

Anker SOLIX Power Dock Pro (EU Single-Phase) Installer Guide







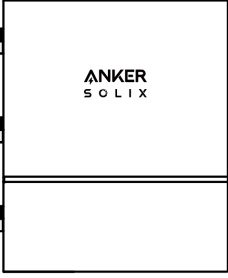
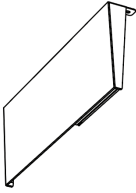
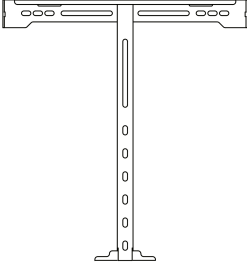
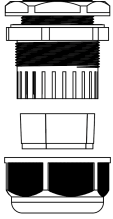
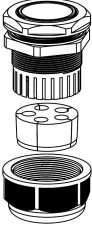

1. Unboxing
2. System Overview
 - Whole Home Backup
 - Partial Home Backup
3. Product Interior View
4. Pre-Installation
 - 4.1 Select Installation Site
 - 4.2 Prepare Cables
 - 4.3 Prepare Tools
 - 4.4 Remove Equipment Door and Inner Panel
5. Mounting the Bracket
6. Electrical Connections
 - 6.1 Wiring Diagrams
 - 6.2 Routing Suggestion
 - 6.3 Connect the PEN Cable
 - 6.4 Connect the PE Busbar
 - 6.5 Connect to Inverter / Backup Loads / Non-Backup Loads / Power Grid
 - 6.6 Connect to Smart Port Loads
 - 6.7 Connect Communication Cables
 - Port Definitions
 - Connect Network Cable for COM2
 - Connect RJ45 Network Cable for COM3
 - Connect DI / DO / RS485 Cable
7. Complete Connections
 - 7.1 Tighten / Seal Routing Hole
 - 7.2 Install Inner Panel and the Cover
 - 7.3 Install Decorative Cover
8. Power On
9. Use the Anker SOLIX Professional App
 - 9.1 Download and Install the App
 - 9.2 Build System
 - 9.3 Storage Settings
 - 9.4 System Configuration
 - 9.5 Post Commissioning

Notice

Appendix 1: Specifications

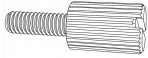
Appendix 2: Compatible Devices

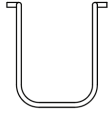
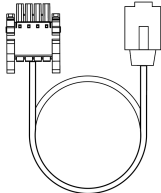
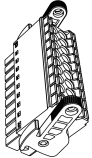
1. Unboxing

			
<p>Anker SOLIX Power Dock Pro</p>	<p>Decorative Cover</p>	<p>T-shaped Rear Bracket</p>	<p>Waterproof Connector (AC Cable Gland) ×6</p>
			
<p>Waterproof Connector (Signal Cable Gland) ×1</p>	<p>Screw (M4 12 mm) ×8</p>	<p>Expansion Bolt (M8 70 mm) ×4</p>	<p>Self-Tapping Screw (M8 70 mm) ×4</p>
			
<p>Thumb Screw (M4 12 mm) ×1</p>	<p>Flange Nut (M4) x1</p>	<p>Circuit Breaker Lockout</p>	<p>Network Cable</p>
			
<p>20-pin Pluggable Terminal Block</p>	<p>Documents</p>		

2. System Overview



- ① Whole-home backup requires a main circuit breaker rated at 63 A or below. For ratings above 63 A, partial home backup must be used.
- ② When connecting the Anker SOLIX X1 Power Module to the Power Dock Pro, a maximum of two X1 units are supported in parallel.
- ③ For a two-inverter parallel connection to the Power Dock Pro, connect the closer inverter to it with a communication cable.

Whole Home Backup

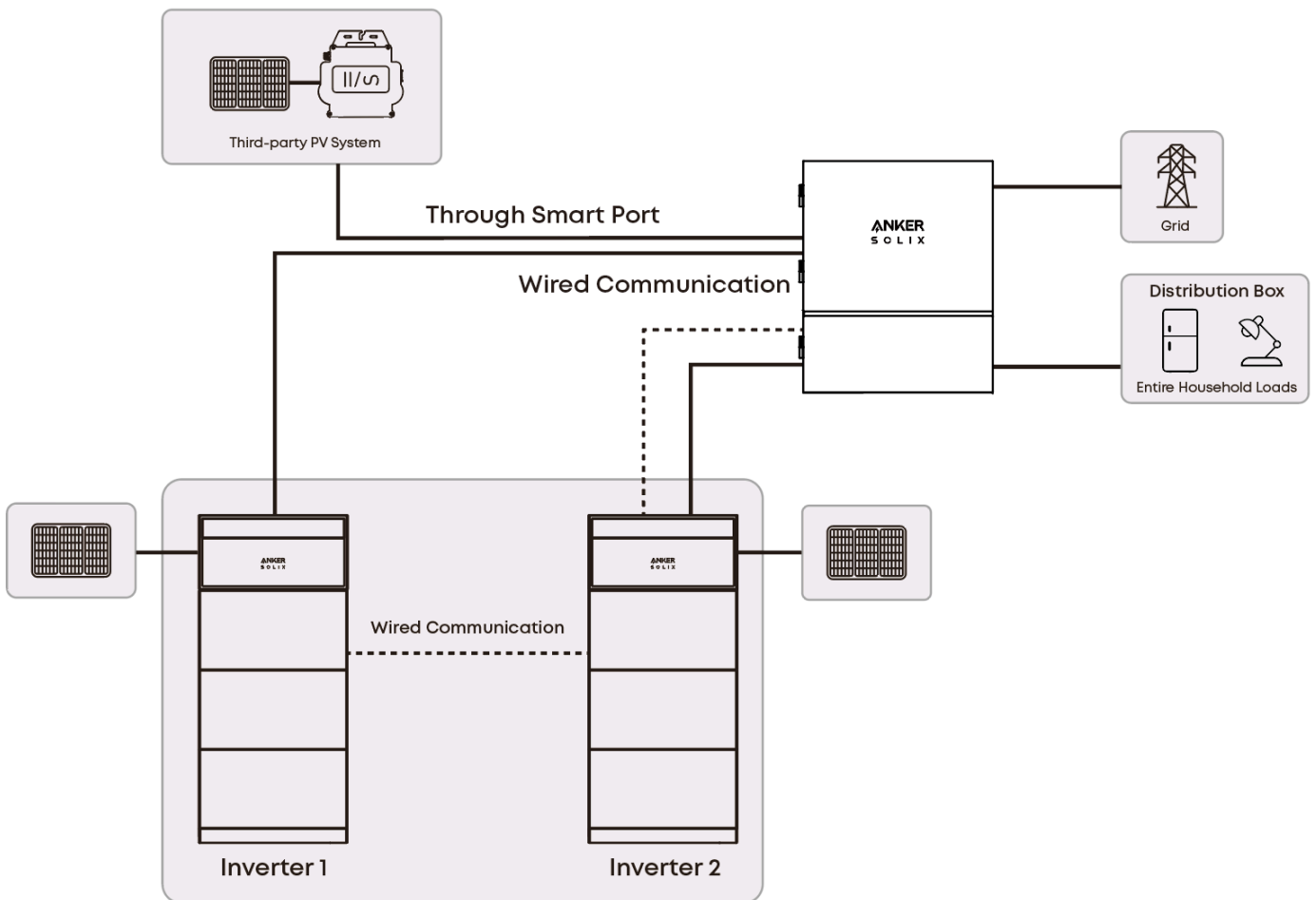

Partial Home Backup



- ① For partial home backup, non-backup load circuits can be kept in the main panel or relocated to a subpanel, depending on the installation setup.
- ② Dashed boxes indicate optional components.

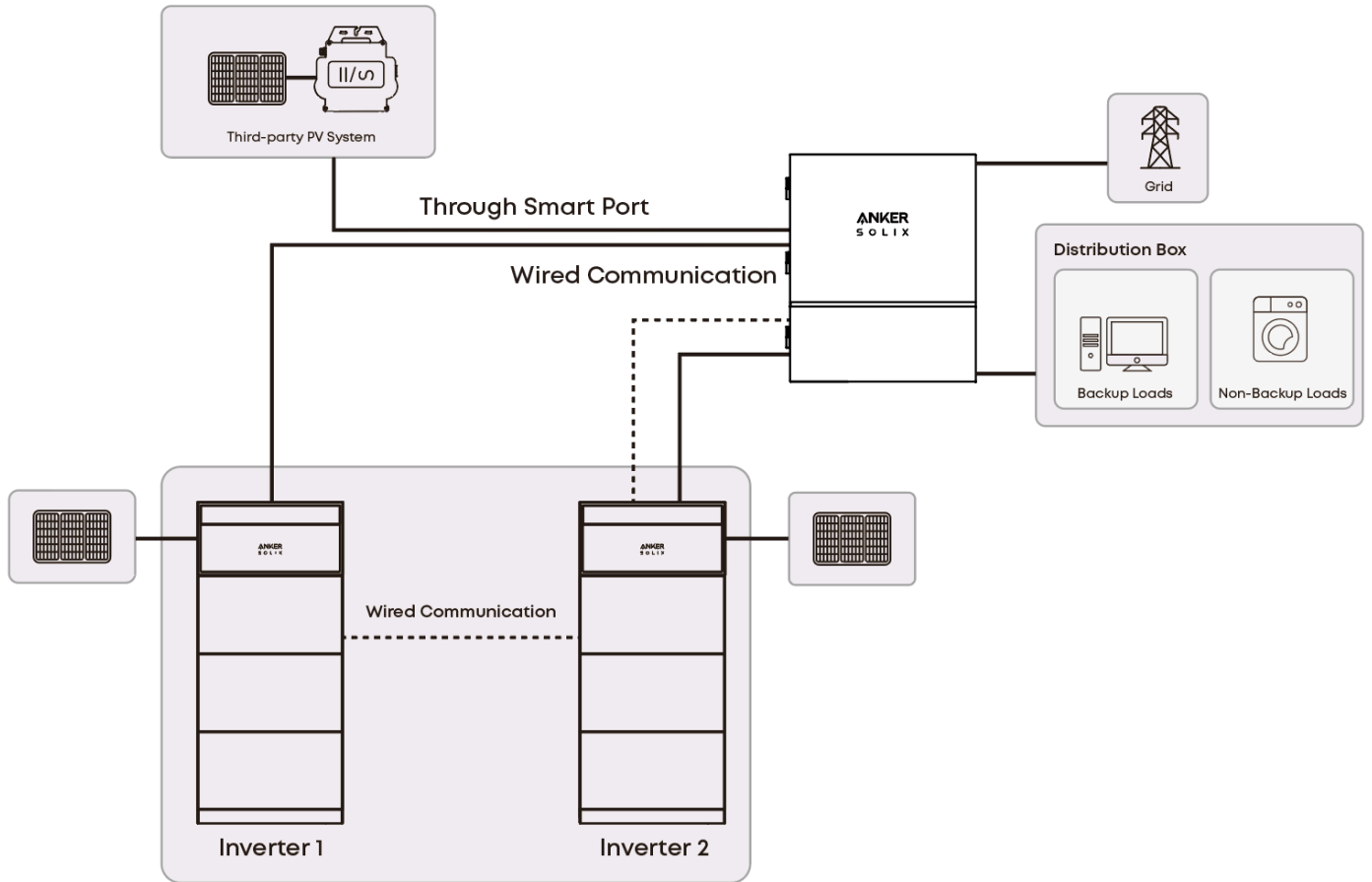

3. Product Interior View



The inverter circuit breakers in the Power Dock Pro can be replaced to match the connected inverter's power rating.

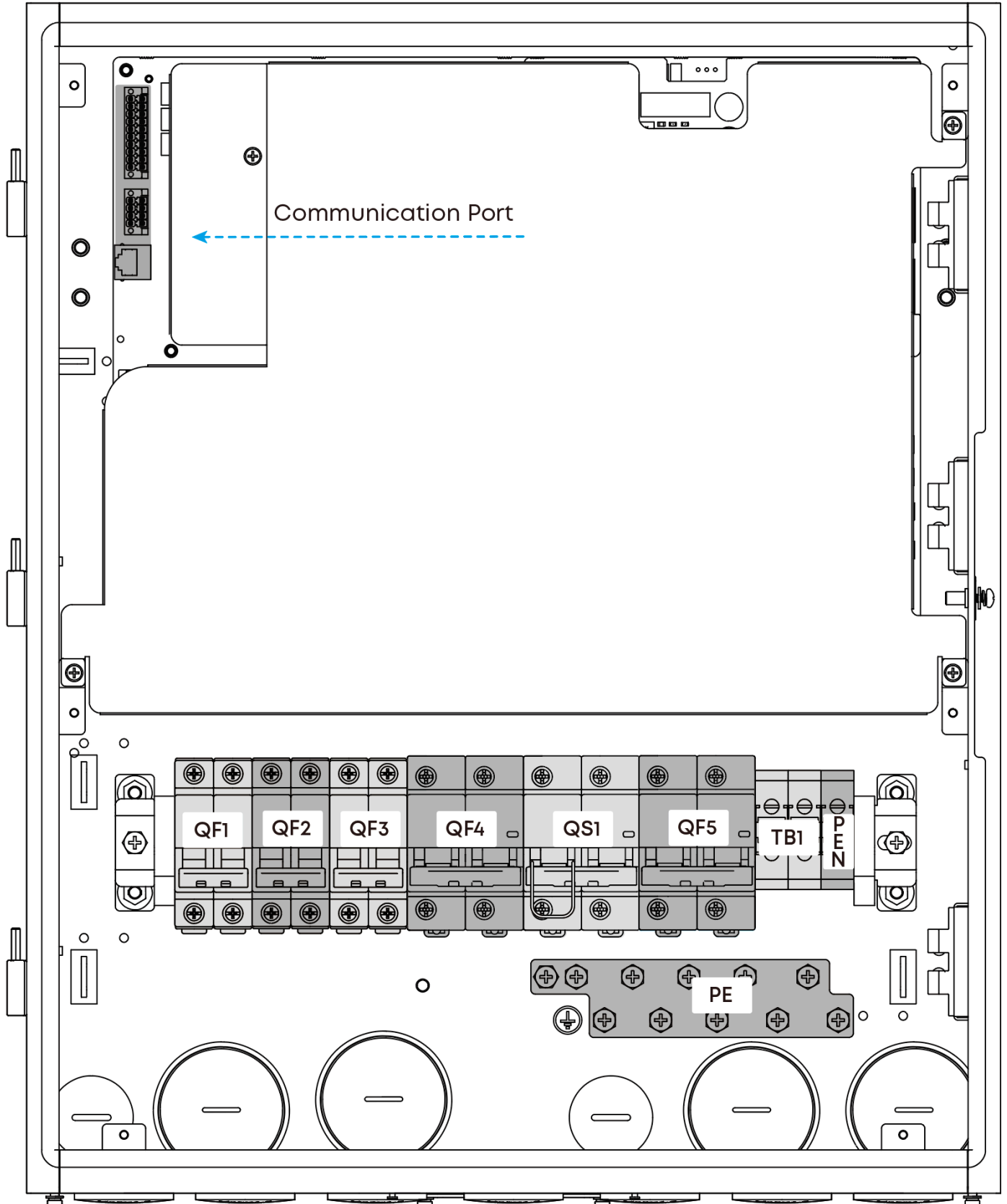

Lable	Function	Description
-	Communication Port	Communication terminal (connecting to DI, DO, RS485,CAN communication cable)
QF1	Smart Port	Miniature circuit breaker (connecting to a third-party solar inverter) *With built-in meter
QF2	Inverter 1	Miniature circuit breaker (connecting to Anker SOLIX X1)
QF3	Inverter 2	Miniature circuit breaker (connecting to Anker SOLIX X1)
QF4	Backup	Miniature circuit breaker (connecting to a backup household load)
QF5	Grid	Miniature circuit breaker (connecting to the power grid) *With built-in meter
QS1	Bypass	Bypass Switch  Keep the bypass switch in the OFF position during normal operation. Turn it ON only if the Power Dock Pro fails to connect to the grid.
-	PEN	Miniature circuit breaker (connecting to the building's Main Earthing Terminal)
TB1	Non-Backup	Terminal Block (connecting to a non-backup household load)
PE	PE Busar	Grounding Copper Busbar

4. Pre-Installation

4.1 Select Installation Site

- Ensure sufficient spacing for cabling, heat dissipation, and safety isolation.
- Install the equipment in a cool, sheltered location, away from direct sunlight and rain.
- When installed outdoors, mount the equipment at least 1 m above the ground and ensure the equipment door is securely closed to prevent water ingress.

Dimensions

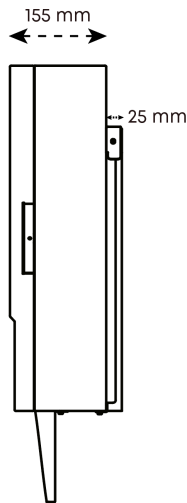
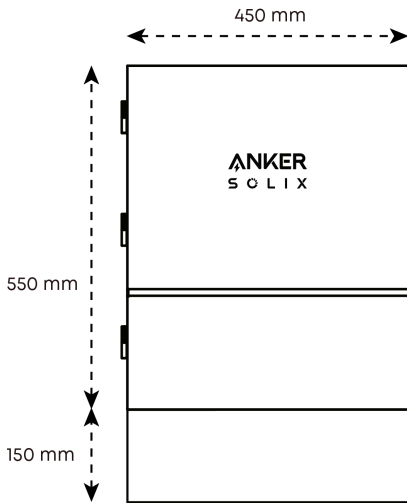

Spacing

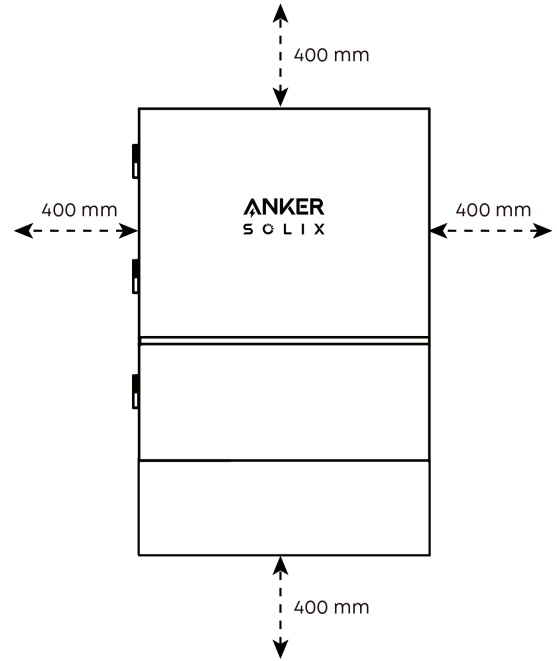

4.2 Prepare Cables



The cable specifications should meet local regulations. Prepare the corresponding cables according to specific application requirements.

No.	Cable Type	Specifications
1	AC cable to connect an inverter	Outdoors five-core copper flexible cable (L1, L2, L3, N, PE) Cross-sectional area of conductor: 6 mm ² Outer diameter: 8-17 mm
2	AC cable to connect a second inverter	
3	AC cable to connect to the power grid	Outdoors five-core copper flexible cable (L1, L2, L3, N, PE) Cross-sectional area of conductor: 16 mm ² Outer diameter: 9-25 mm
4	AC cable to connect backup household loads	
5	AC cable to connect non-backup household loads	
6	AC cable to connect a third-party PV system or other smart load devices	Outdoors five-core copper flexible cable (L1, L2, L3, N, PE) Cross-sectional area of conductor: ≤16 mm ² (select wire gauge based on actual load) Outer diameter: 9-25 mm

7	Communication cable for the inverter	Outdoor eight-conductor shielded twin-twisted pair cable (EIA/TIA568B standard network cable) Cross-sectional area of core conductor: 0.13-0.2 mm ² Outer diameter: 4-7.5 mm Cable length: < 30 m
8	RS485 network cables	Outdoor two-conductor shielded cable Cross-sectional area of core conductor: 0.2-1.5 mm ² Outer diameter: 2-4 mm
9	DI/DO signal cables	Outdoor two-conductor shielded cable Cross-sectional area of core conductor: 0.2-1.5 mm ² Outer diameter: 2-4 mm
10	PEN Cable	Cross-sectional area of conductor: 16 mm ² Outer diameter: 9-25 mm

4.3 Prepare Tools





Prepare the following tools before installation. They are not included in the package.

Wear appropriate personal protective equipment (PPE) and follow safe electrical work practices.

Personal Protective Equipment

		
Gloves(Cut-Resistant, Insulated)	Dust Mask	Safety Goggles
		
Protective Footwear	Safety Hat	

Installation Tools

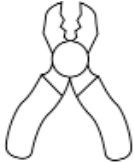
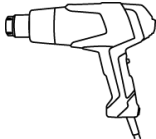
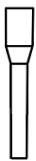
			
Level	Tape Measure	Marker	Power Drill
			
Hammer	Phillips Screwdriver	Cable Cutter	OT Terminal Crimper
			
Wire Stripper	RJ45 Crimping Tool	Pliers	Cold Terminal Crimping Pliers
			
Torque Socket Wrench	Heat Gun	Cable Tie	Sealant
			
OT Terminal	Cold-pressed Terminal		

4.4 Remove Equipment Door and Inner Panel



Keep the removed screws in a safe place, as they will be needed for reinstallation.

- ① Loosen the screw to open the equipment door.
- ② Remove the PE Cable.
- ③ (Optional) Remove the equipment door.
- ④ Loosen the screws to remove the inner panel.

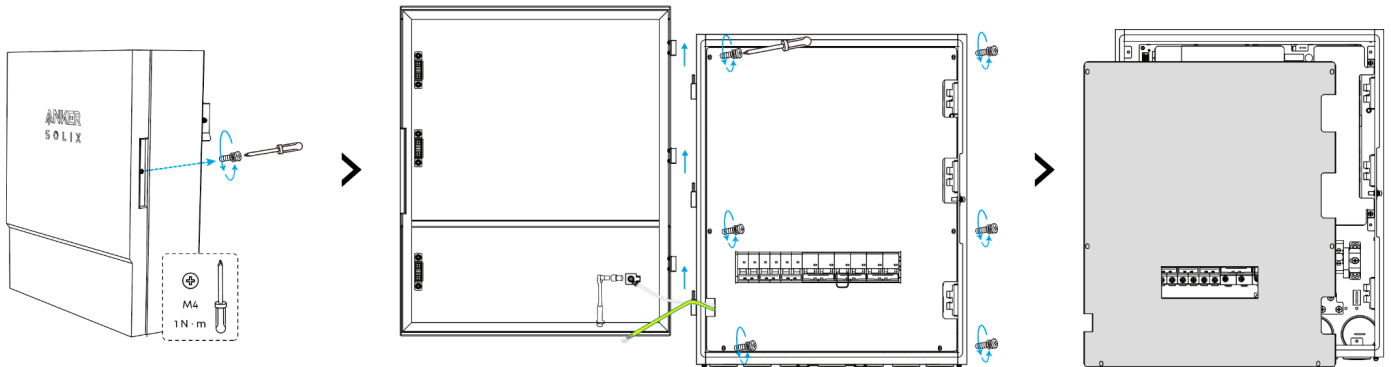

5. Mounting the Bracket



- ① Select self-tapping screws or expansion bolts based on the wall material to secure the bracket. The illustration below demonstrates the installation using expansion bolts.
- ② If routing cables from the rear, complete all wiring before securing the screws on the bottom of the mounting bracket for easier access.

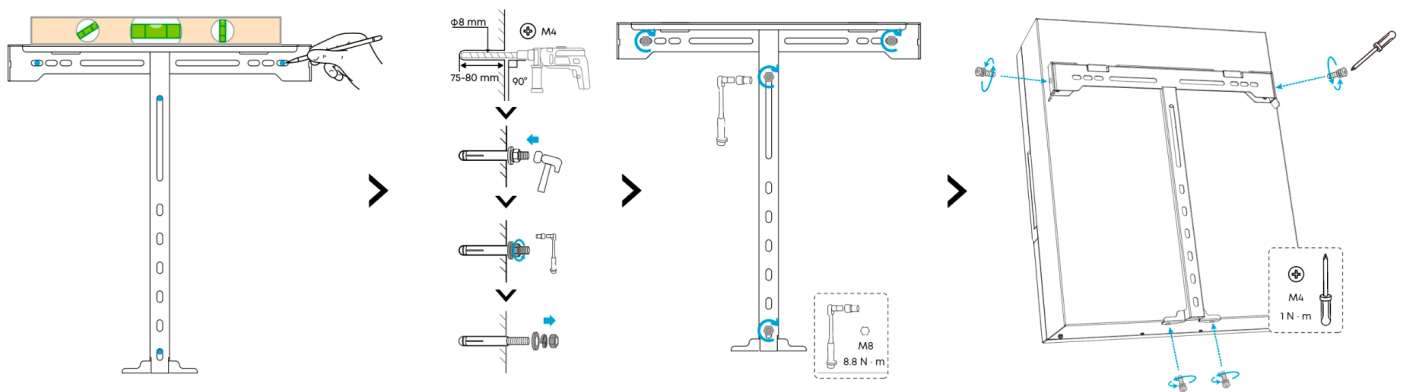

6. Electrical Connections



- Before wiring, ensure the main circuit breaker is off.
- Disconnect and remove wiring of existing Anker SOLIX energy storage systems from the distribution box for reconnection.

6.1 Wiring Diagrams



- Dashed boxes indicate optional components.
- When the Power Dock Pro is installed, the Backup Port on the inverter does not need to be connected.
- It is recommended to keep the power factor (PF) of loads connected to the Backup Port within the range of 0.7 to 1. High-power or high-inrush inductive loads, such as air conditioners, HAT and heat pump, are not recommended for connection to the Backup Port, as they may cause system instability or reduce backup capacity.
- Diagrams below are for reference only. For detailed wiring instructions, refer to the following sections.
- Diagrams below cover both whole-home backup and partial home backup scenarios. If whole-home backup is all you need, disregard the Non-Backup wiring section.
- Two inverters can be connected in parallel to the Power Dock Pro. For detailed parallel connection instructions, refer to:
[X1 Hybrid Single-Phase System AC Grid Port Parallel Function for Europe and UK](#)

Scenario 1: Install Power Dock Pro and Inverter Together

- Whole Home Backup
- Partial Home Backup (With non-backup loads connected to the Non-Backup terminal of the Power Dock Pro)

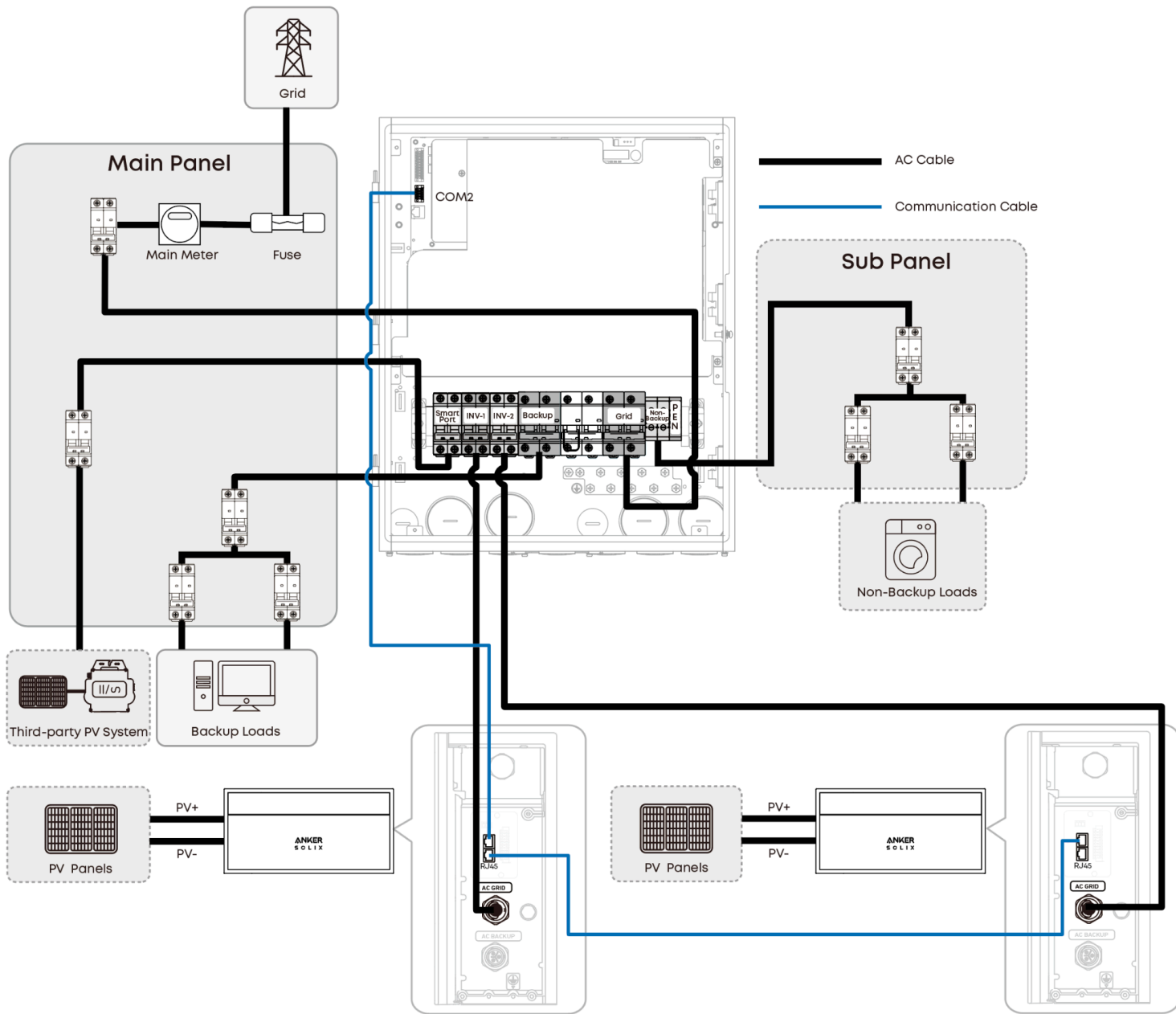

Scenario 2: Add Power Dock Pro to Existing System

- Whole Home Backup
- Partial Home Backup (With non-backup loads connected to the Non-Backup terminal of the Power Dock Pro)

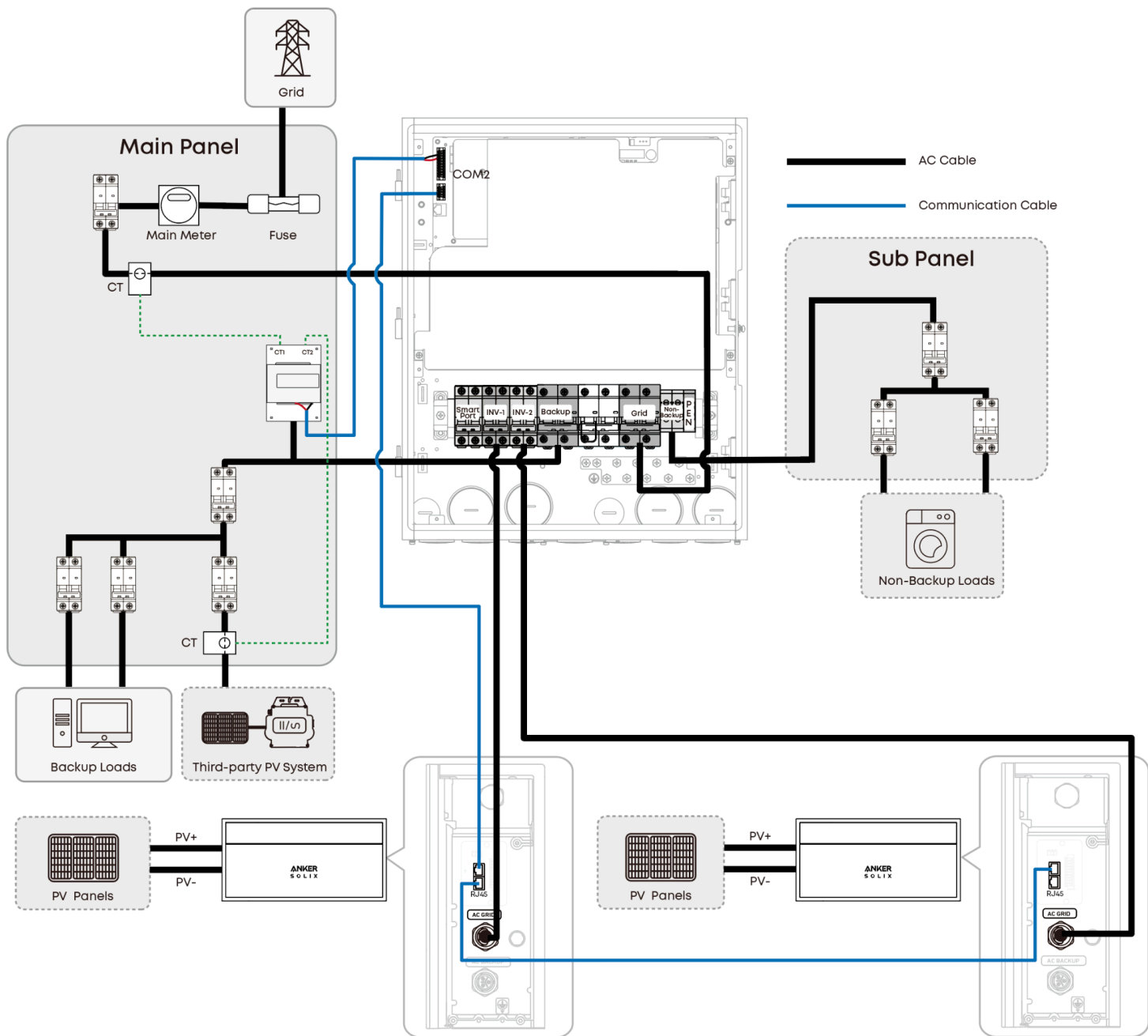

Special Scenario

With Non-backup loads connected upstream of the Power Dock Pro.

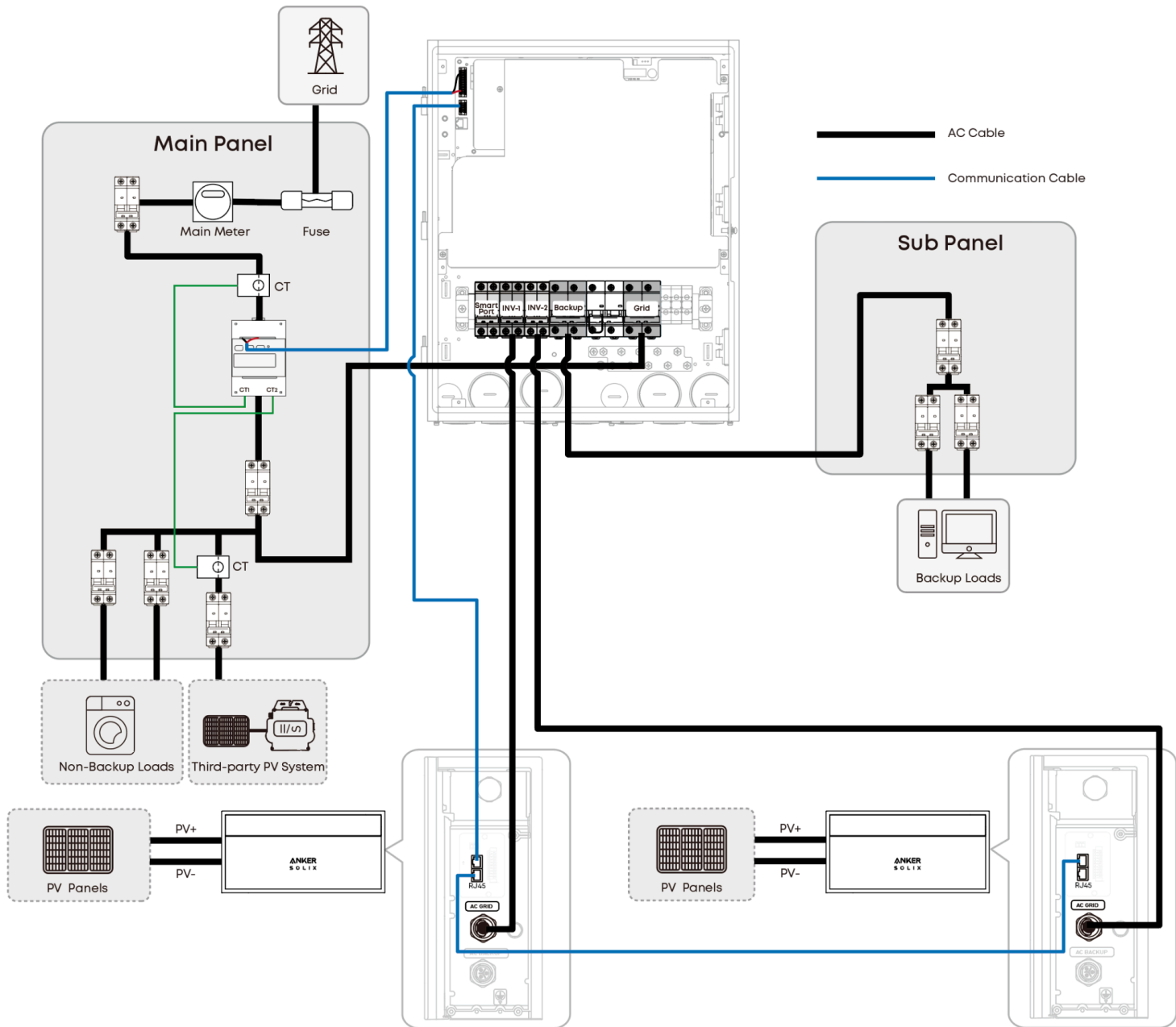

Meter Configuration

- If a third-party PV system is connected but not to the Smart Port, an external dual-channel meter is required.
- When non-backup loads are installed upstream of the Power Dock Pro, a dual-channel external meter is required if a third-party PV system is present. If no third-party PV system is present, a single-channel external meter is sufficient.



Refer to Appendix 2 for compatible meters and inverters models.

6.2 Routing Suggestion



Cable colours are for reference. Select cables in accordance with local regulations.

Option 1: Bottom Cable Entry

1. Install waterproof connectors.

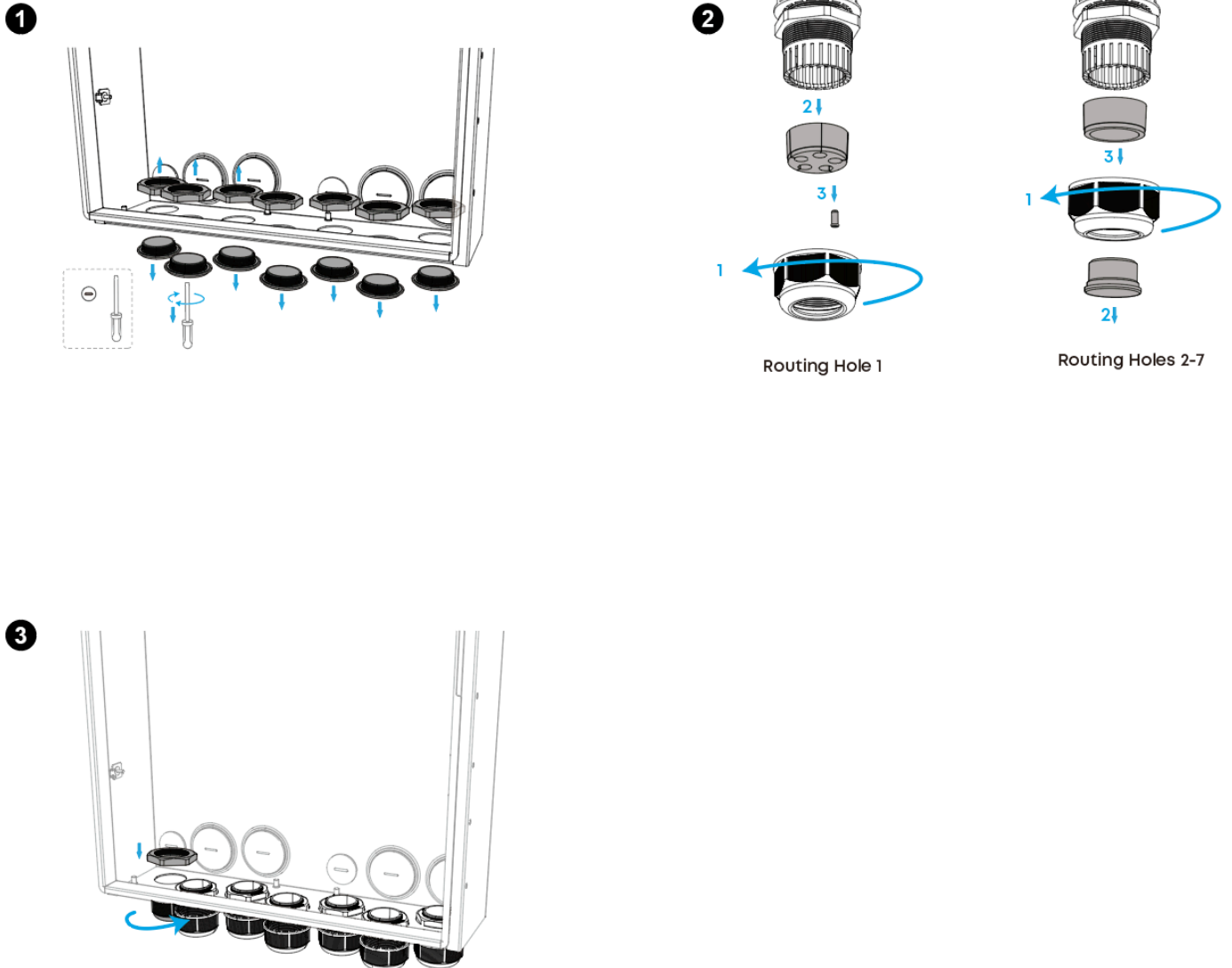

2. Route cables through waterproof connectors.

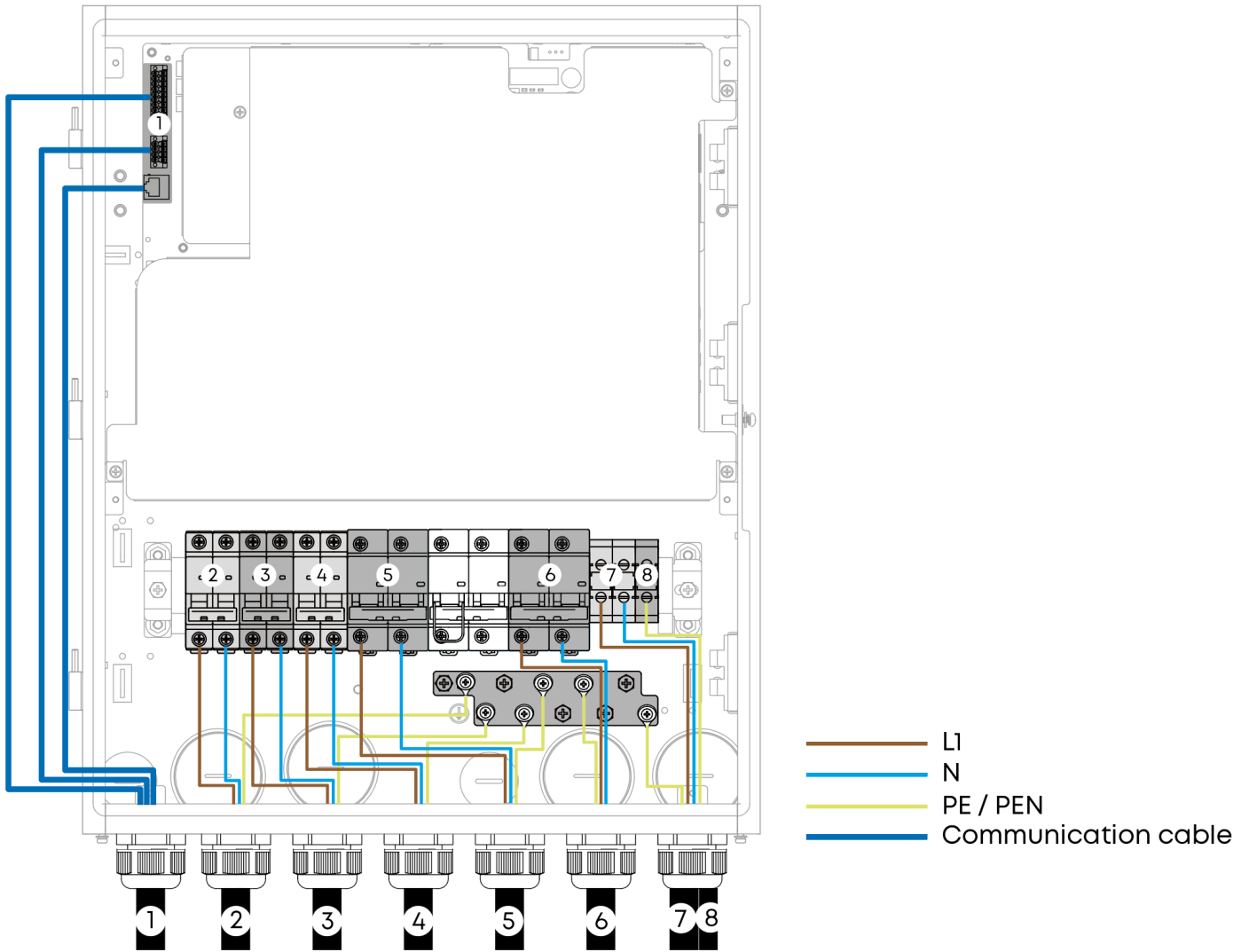

1	Communication cable	2	Smart port cable
3	Inverter cable	4	Inverter cable
5	Backup load cable	6	Grid cable
7	Non-backup load cable	8	PEN cable

Option 2: Back Cable Entry



It is recommended to route two cable sets through the large hole and one through the small hole.

1. Remove covers from the rear holes

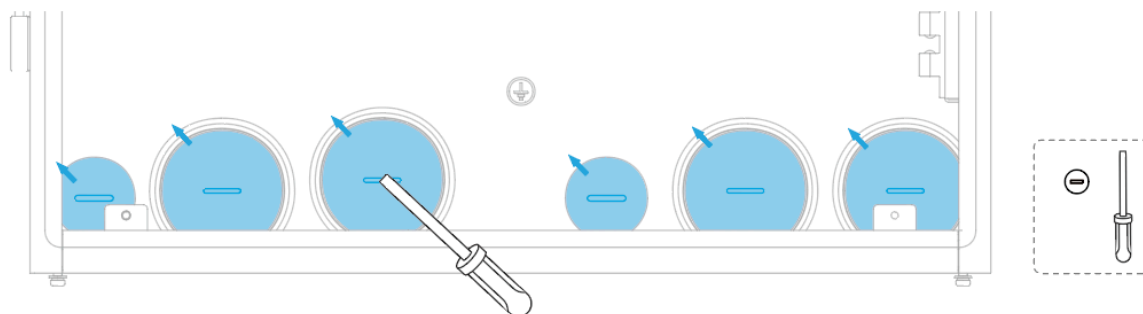

2. Route cables through the hole.

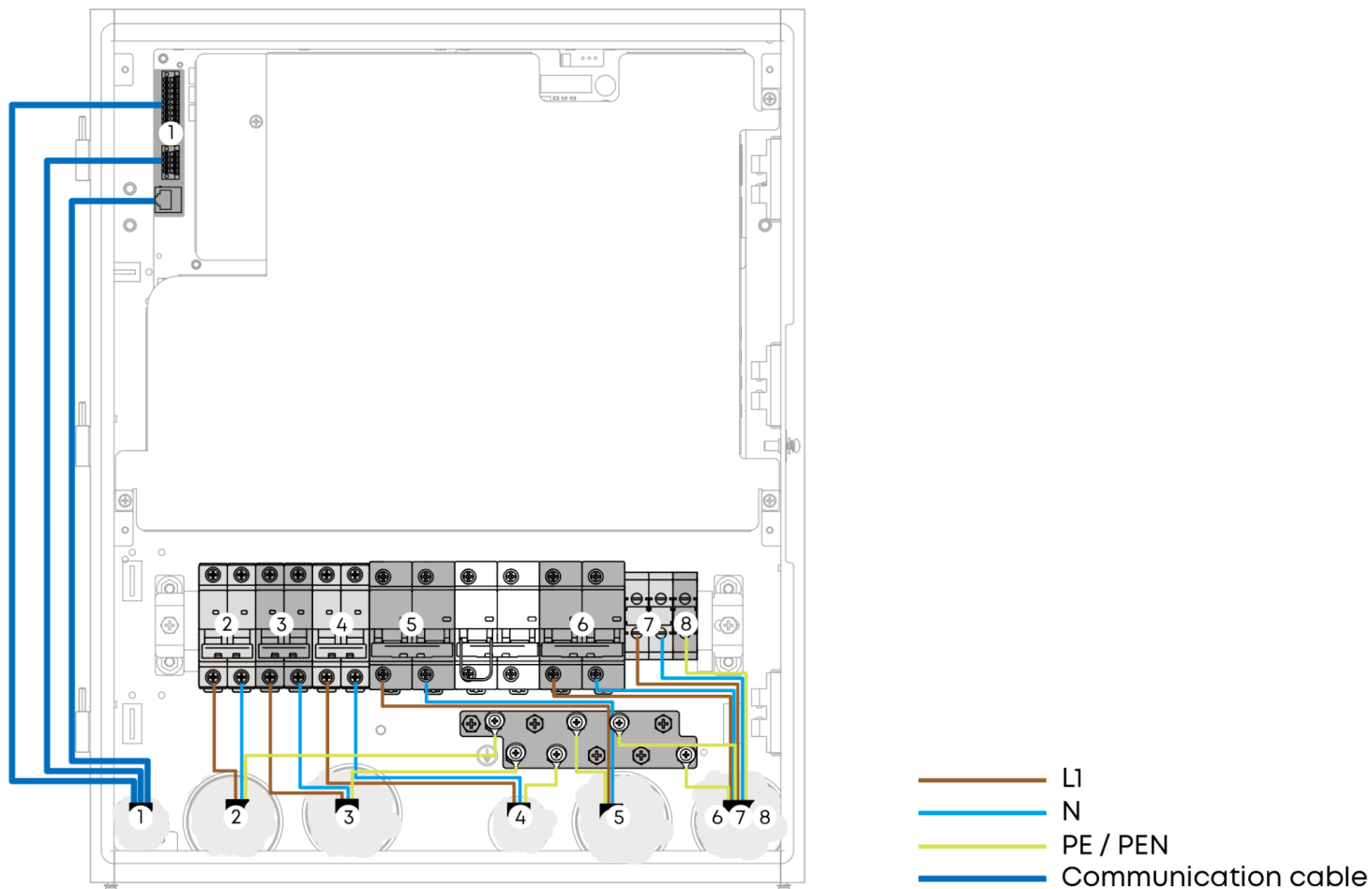

1	Communication cable	2	Smart port cable
3	Inverter cable	4	Inverter cable
5	Backup load cable	6	Grid cable
7	Non-backup load cable	8	PEN cable

6.3 Connect the PEN Cable

Option 1: Bottom Cable Entry

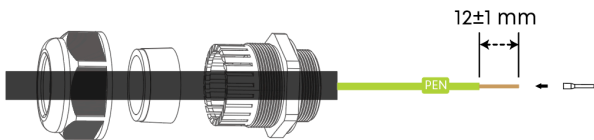
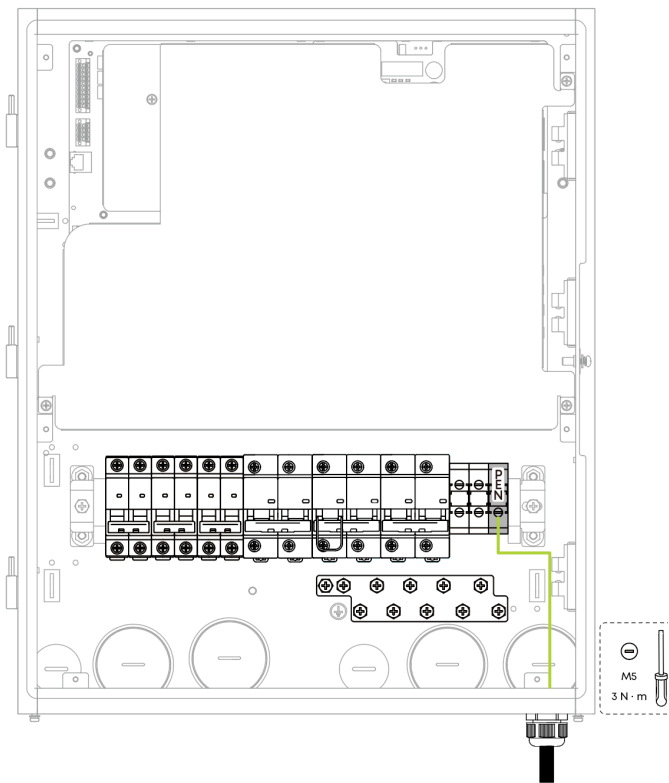

Option 1: Back Cable Entry

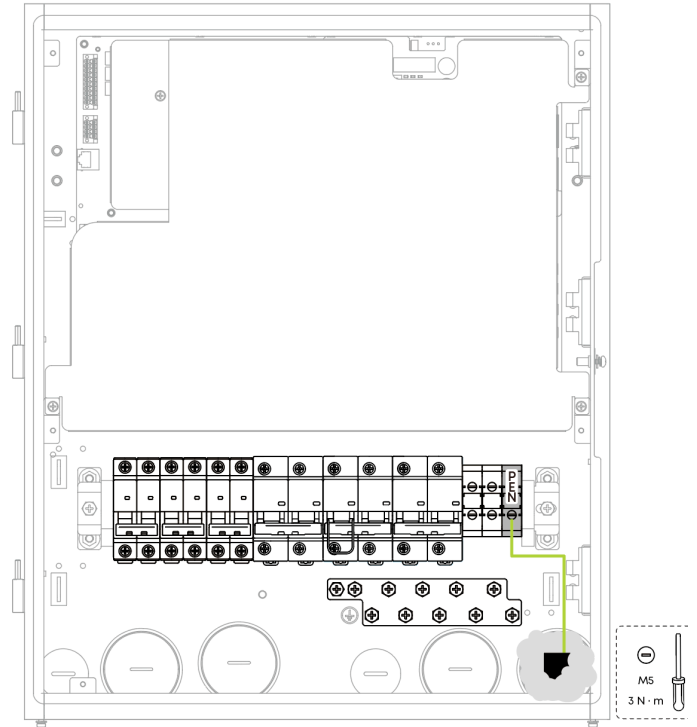

6.4 Connect the PE Busbar

Connect the PE busbar of the Power Dock Pro to the PE busbar of the distribution panel.

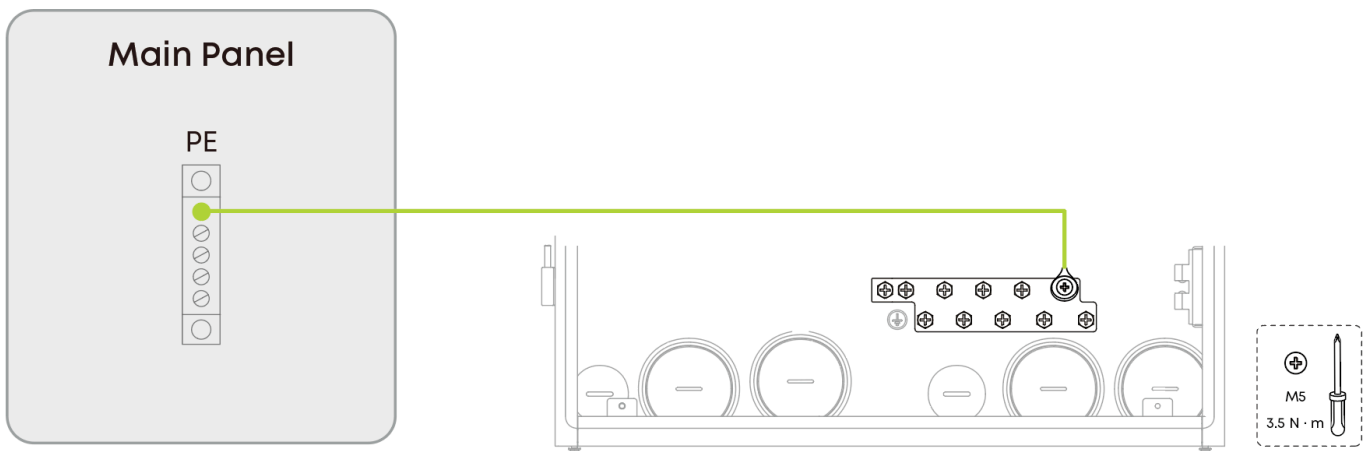

6.5 Connect to Inverter / Backup Loads / Non-Backup Loads / Power Grid



- The methods for connecting an inverter, backup loads, non-backup loads and power grid are the same. This section takes the inverter 1 for example.
- Tighten the circuit breaker terminals to the specified torque: 3.5 N·m for 125 A breakers and 2 N·m for 63 A and 32 A breakers.

Option 1: Bottom Cable Entry

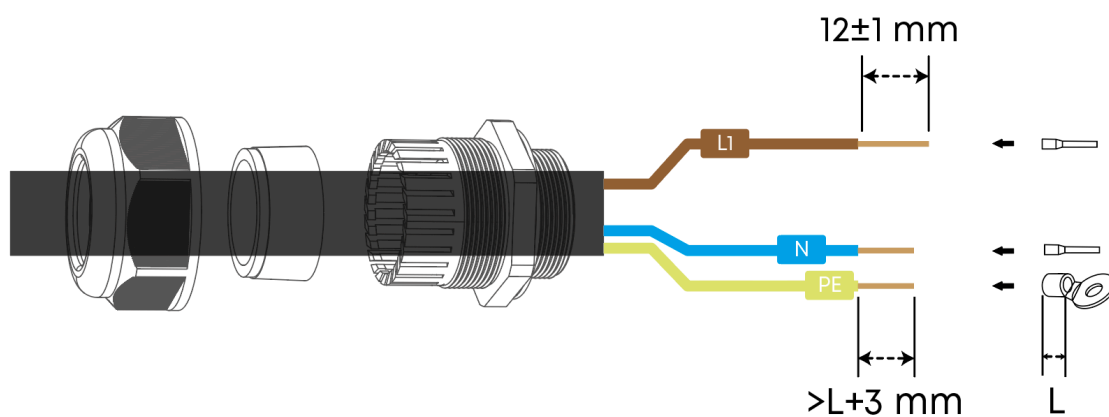
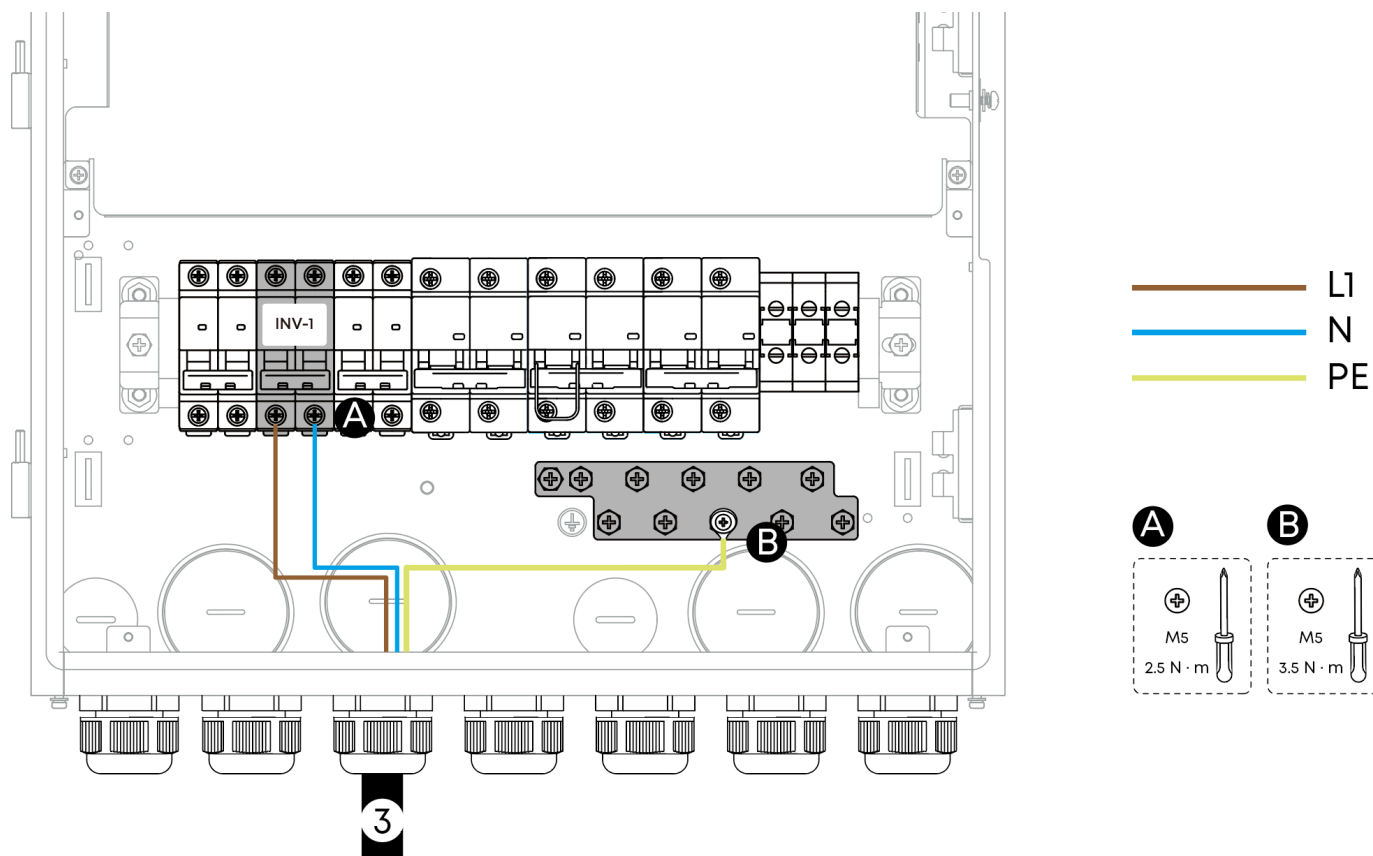

Option 2: Back Cable Entry

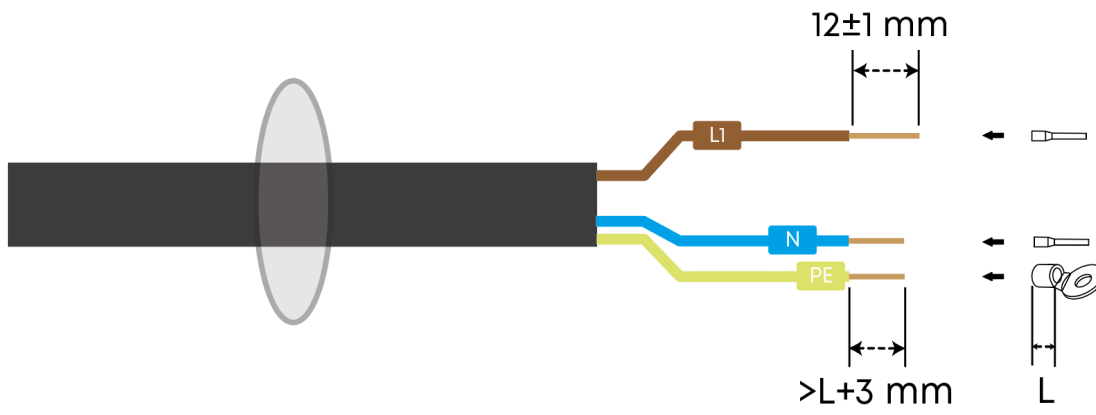
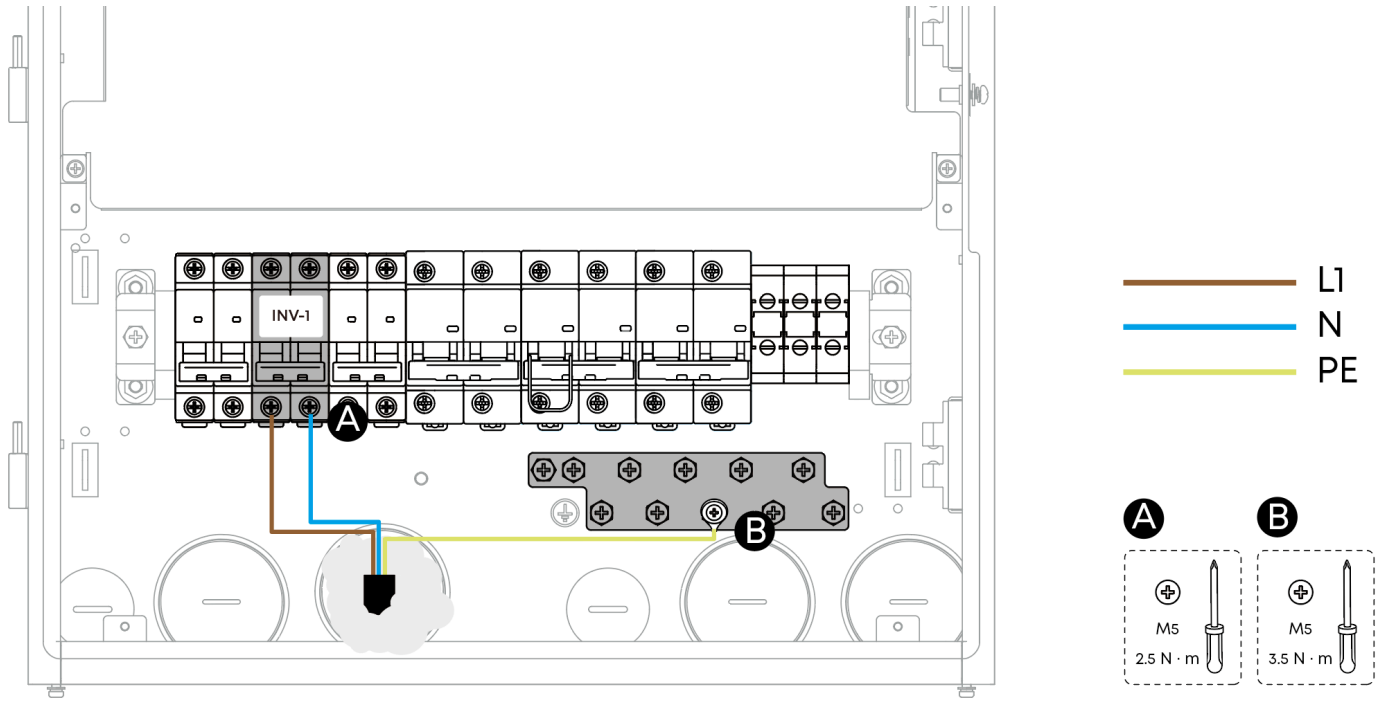

6.6 Connect to Smart Port Loads



For the Smart Port circuit breaker, the neutral (N) wire does not need to be connected, except when connecting a generator.

Option 1: Bottom Cable Entry

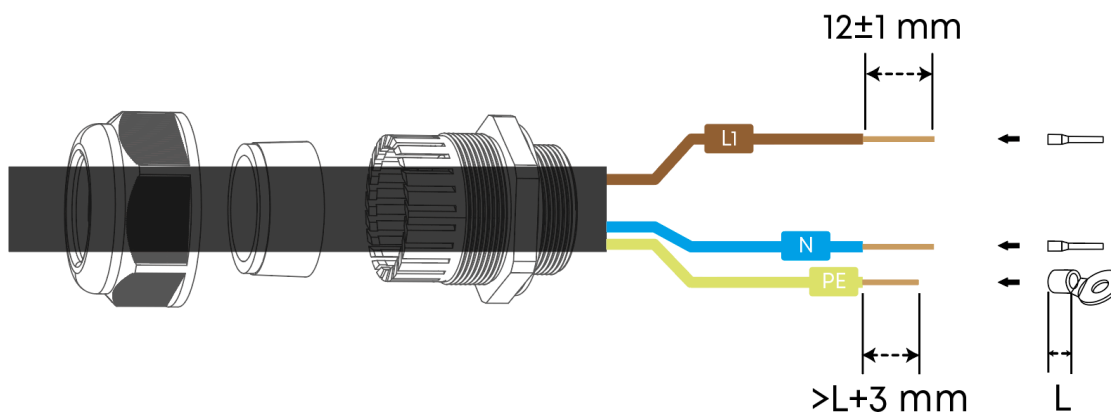
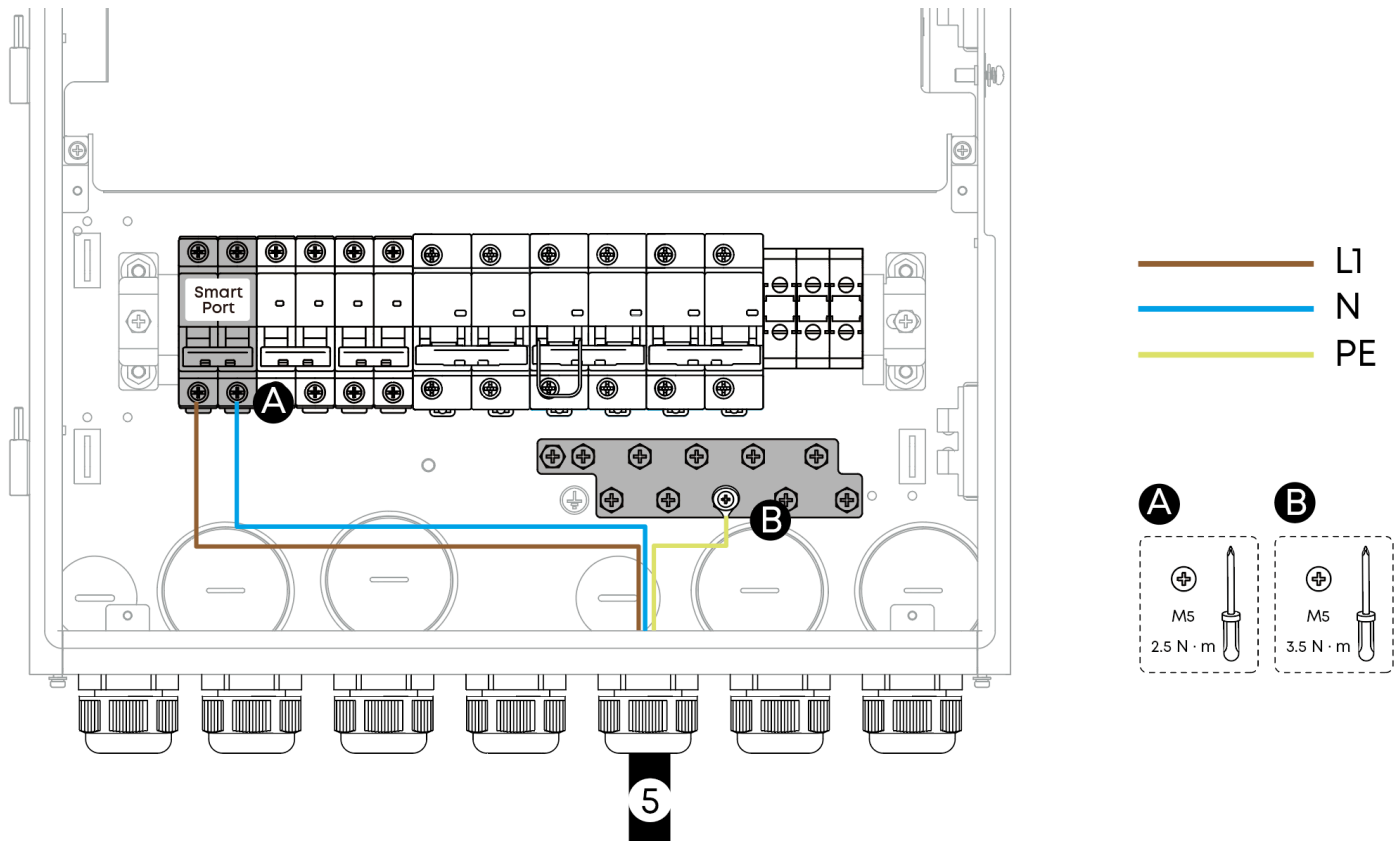

Option 2: Back Cable Entry

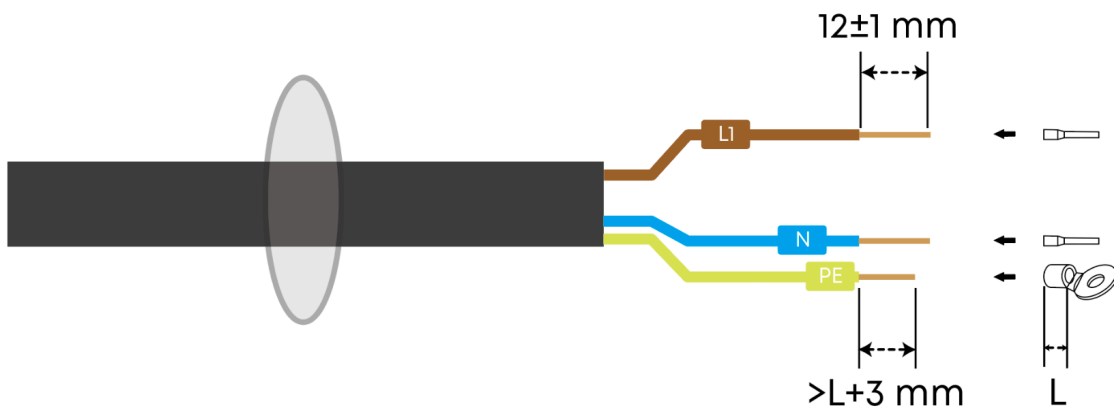
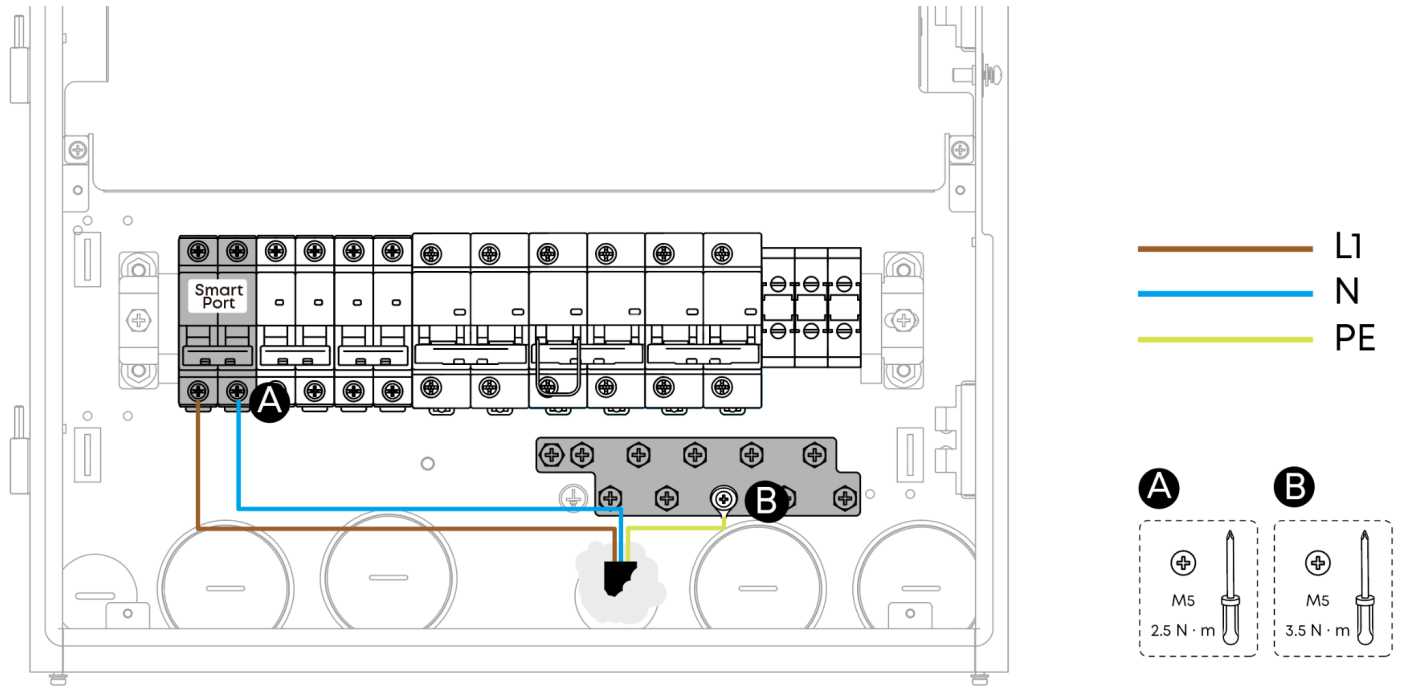

6.7 Connect Communication Cables

Port Definitions

COM Port	Definition				Function
COM 1	20	N/A	19	N/A	Idle.
	18	DO1_COM (Digital Output 1 - Common)	17	DO1_NO (Digital Output 1 - Normally Open)	Reserved
	16	DO2_COM (Digital Output 2 - Common)	15	DO2_NO (Digital Output 2 - Normally Open)	
	14	GEN_DO (Generator - Digital Output)	13	GEN_NO (Generator - Normally Open)	
	12	N/A	11	GEN_NC (Generator - Normally Closed)	Reserved
	10	EPO_GND (Emergency Power Off Ground)	9	EPO (Emergency Power Off)	
	8	DI_GND (Digital Input Ground)	7	DI (Digital Input)	Reserved
	6	12V_GND (Power Ground)	5	12V_OUT (Power Output)	Reserved
	4	RS485B	3	RS485A	Used to connect the equipment over RS485, e.g., smart meter.
	2	N/A	1	N/A	Idle.
COM 2	8-pin communication terminal (cable included for this port)				Used to connect Anker SOLIX X1 Power Module
COM 3	RJ45 connector				Reserved

Connect Network Cable for COM2

The cable for COM 2 is included in the accessory kit.

If you need to make your own cable:



1. Do not replicate the wiring sequence of the included communication cable; instead, strictly adhere to the wiring sequence illustrated in the diagram below.
2. Ensure the Phoenix Contact terminal and RJ45 connector follow the same wiring sequence.



Required Cable Specifications:

Outdoor eight-conductor shielded twin-twisted pair cable (EIA/TIA568B standard network cable)

Cross-sectional area of core conductor: 0.13-0.2 mm²

Outer diameter: 4-7.5 mm

Cable length: < 30 m

Option 1: Bottom Cable Entry

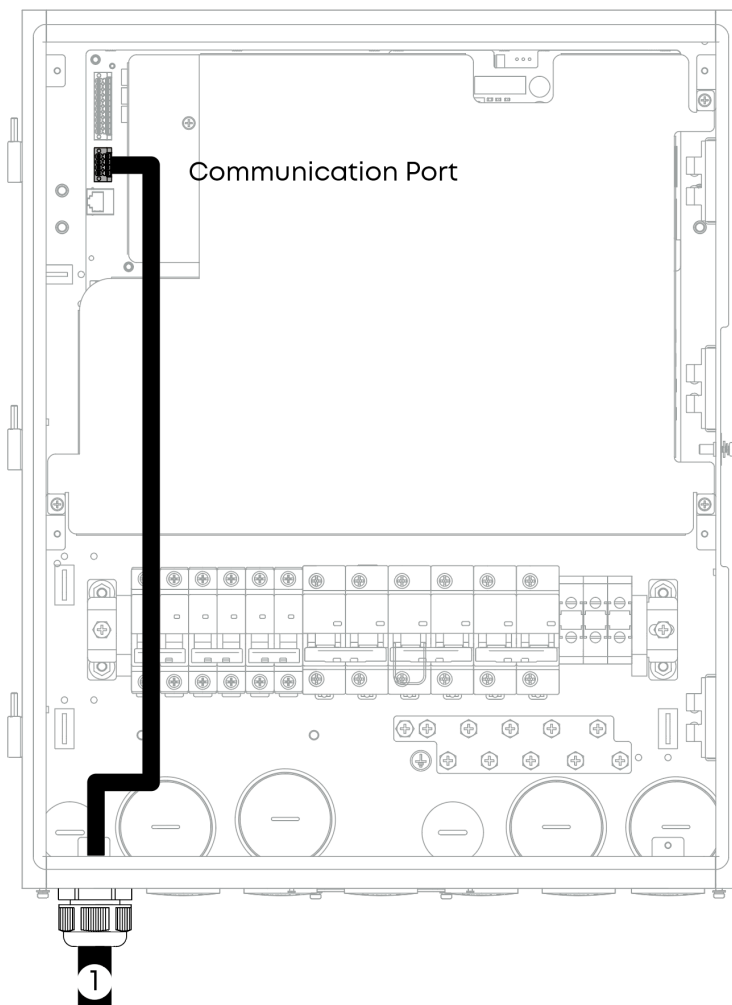

1

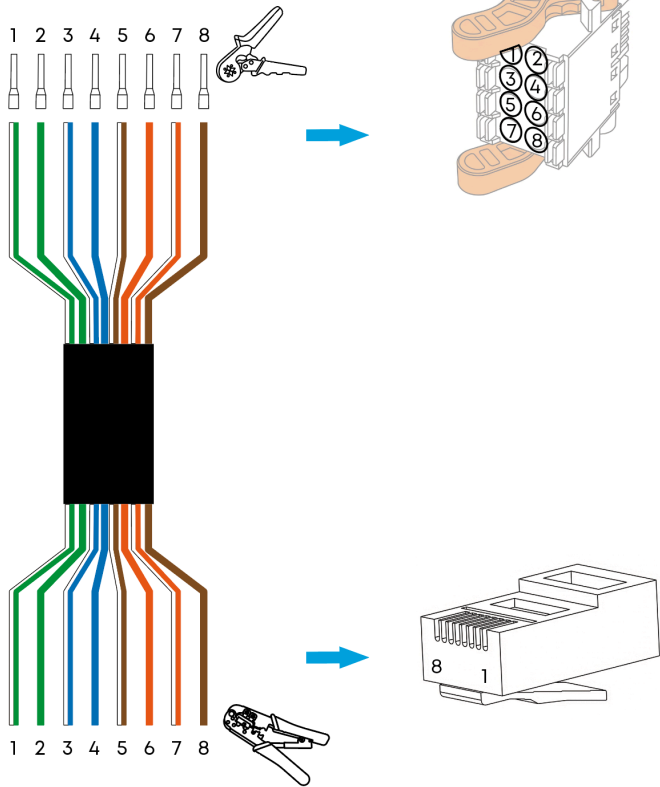

1	White / Green
2	Green
3	White / Blue
4	Blue
5	White / Brown
6	Orange
7	White / Orange
8	Brown

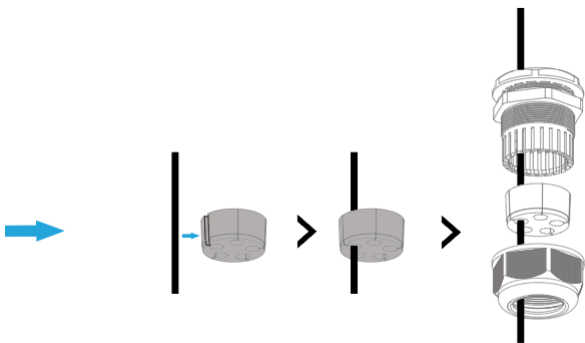

2

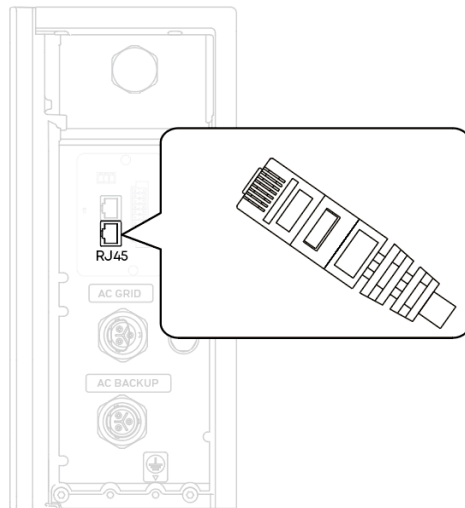
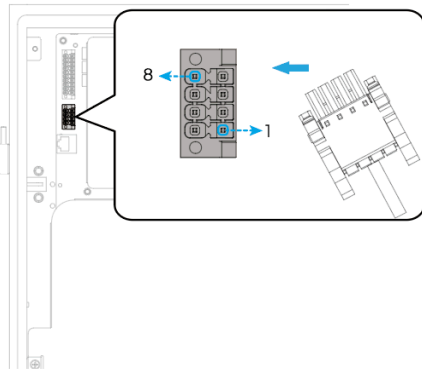

Anker SOLIX X1 Power Module

Option 2: Back Cable Entry

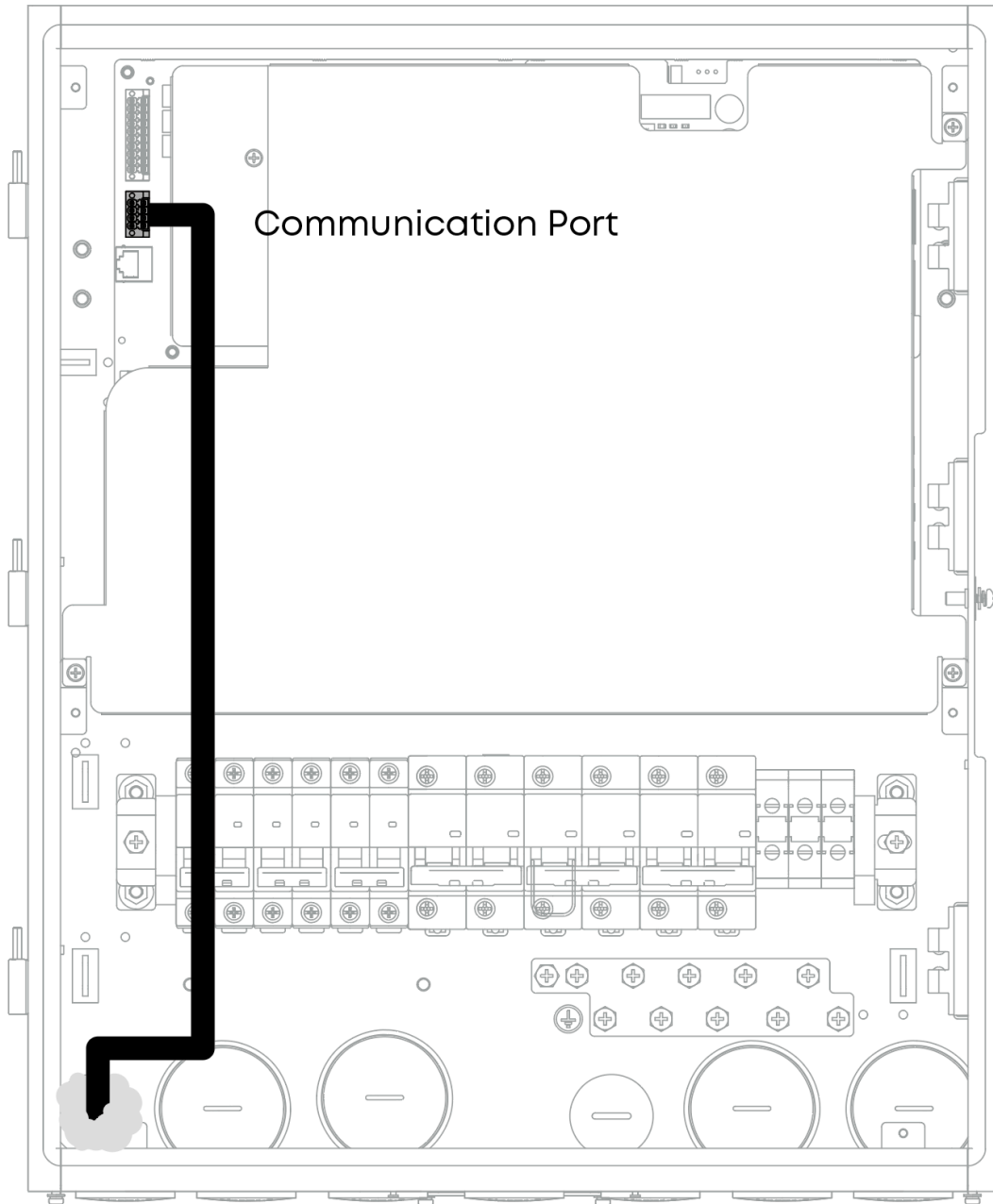

1

1 2 3 4 5 6 7 8

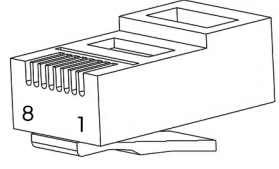
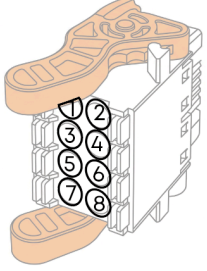
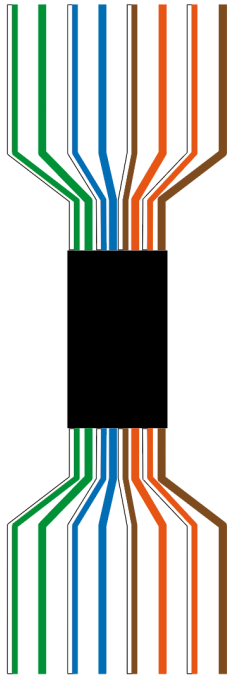

1 2 3 4 5 6 7 8

1	White / Green
2	Green
3	White / Blue
4	Blue
5	White / Brown
6	Orange
7	White / Orange
8	Brown

2

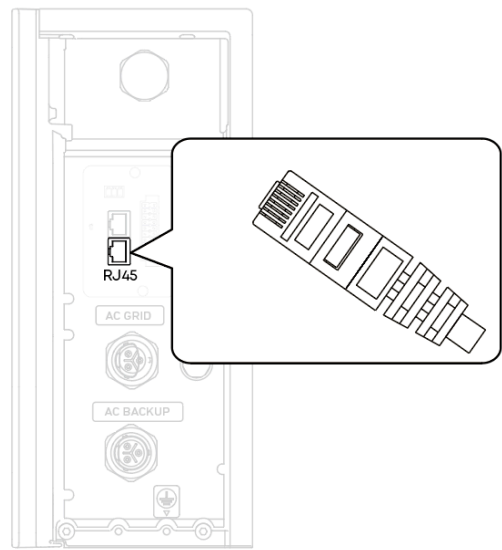
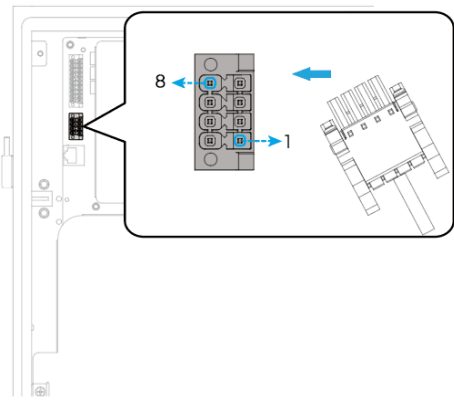

Anker SOLIX X1 Power Module

Connect RJ45 Network Cable for COM3



Required Cable Specifications:

Outdoor eight-conductor shielded twin-twisted pair cable (EIA/TIA568B standard network cable)

Cross-sectional area of core conductor: 0.13-0.2 mm²

Outer diameter: 4-7.5 mm

Cable length: < 50 m

Option 1: Bottom Cable Entry

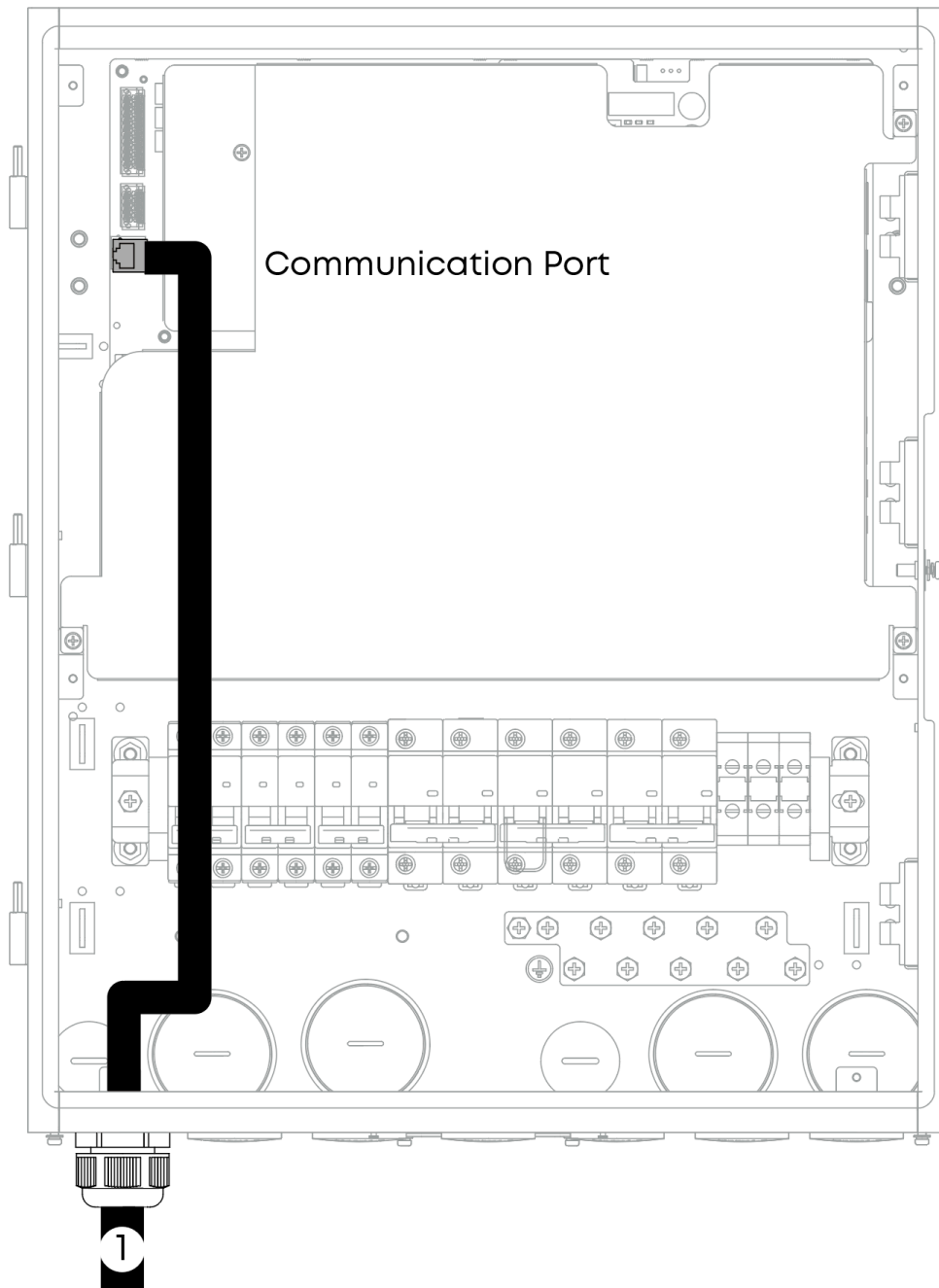

1

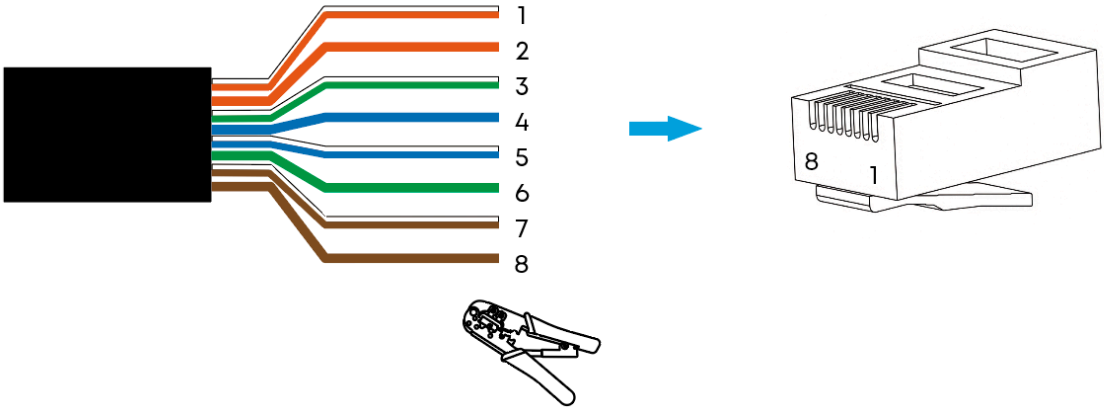

2

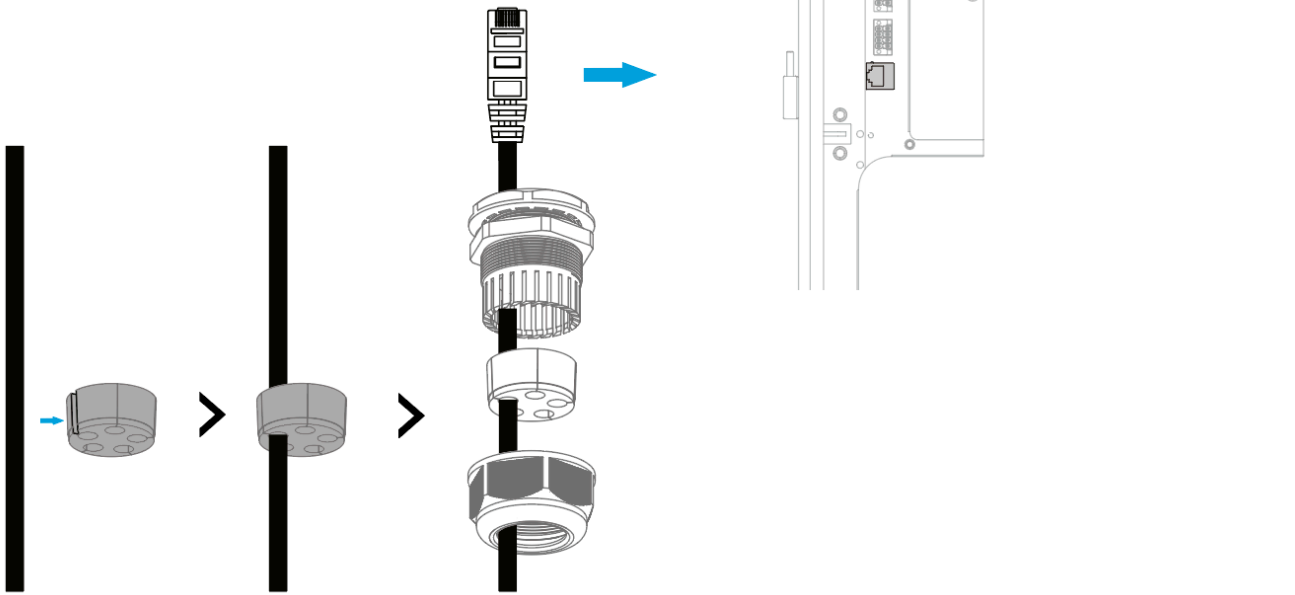

Option 2: Back Cable Entry

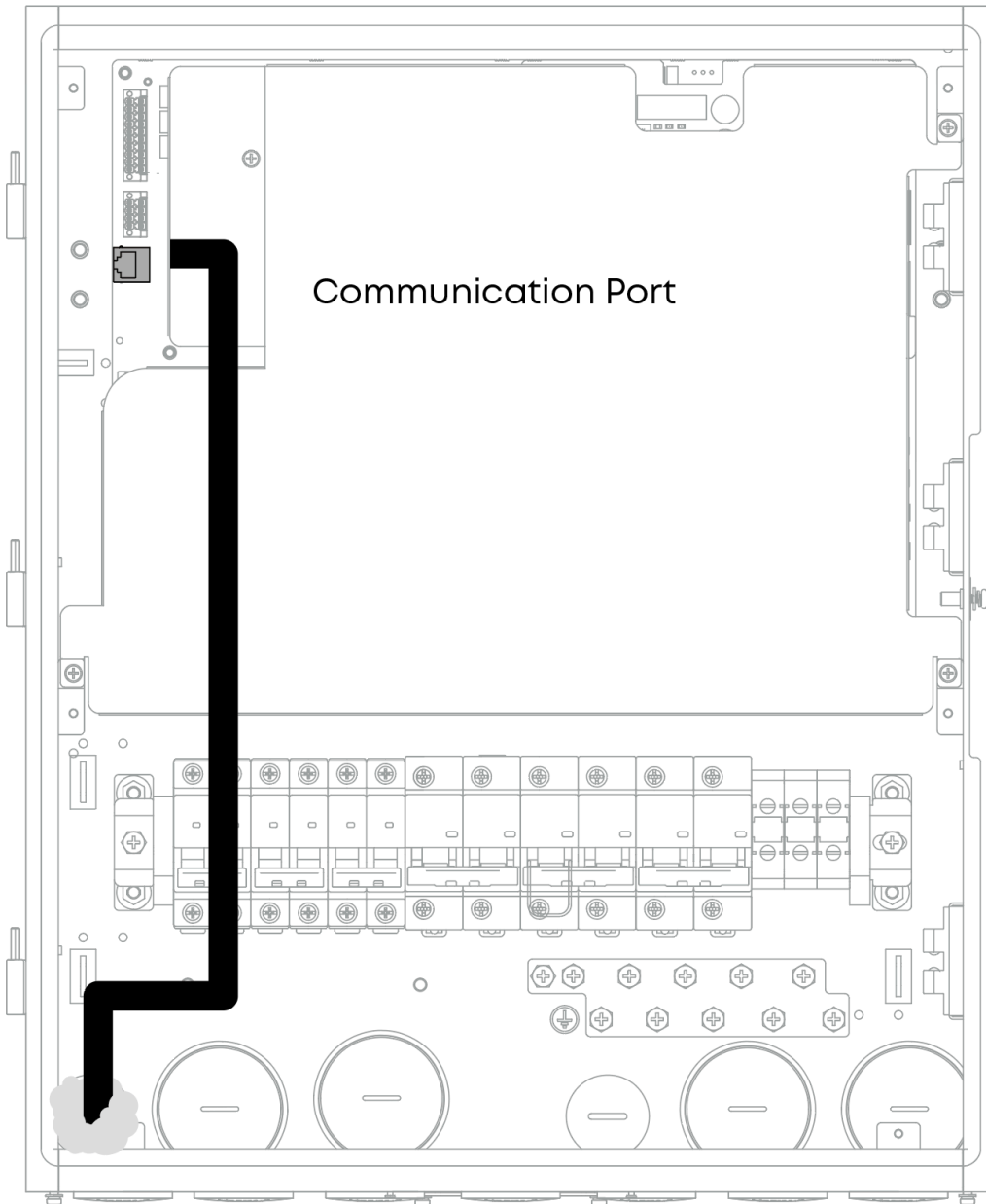

1

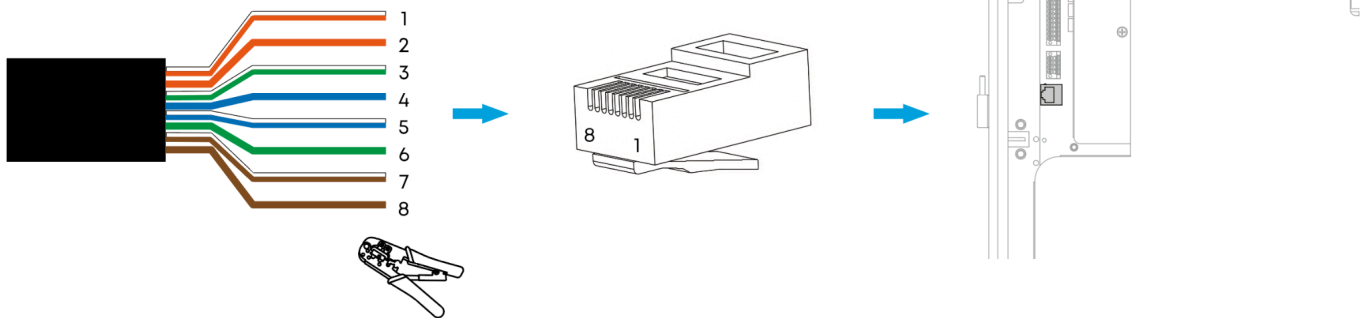

Connect DI / DO / RS485 Cable

The method to connect the DI / DO / RS485 cable is the same. This section takes connecting the RS485 cable as an example.



Required Cable Specifications:

Outdoor two-conductor shielded cable

Cross-sectional area of core conductor: 0.2-1.5 mm²

Outer diameter: 2-4 mm

CAUTION: When wiring, always follow the phase sequence markings of the on-site electrical system during wiring.

Option 1: Bottom Cable Entry

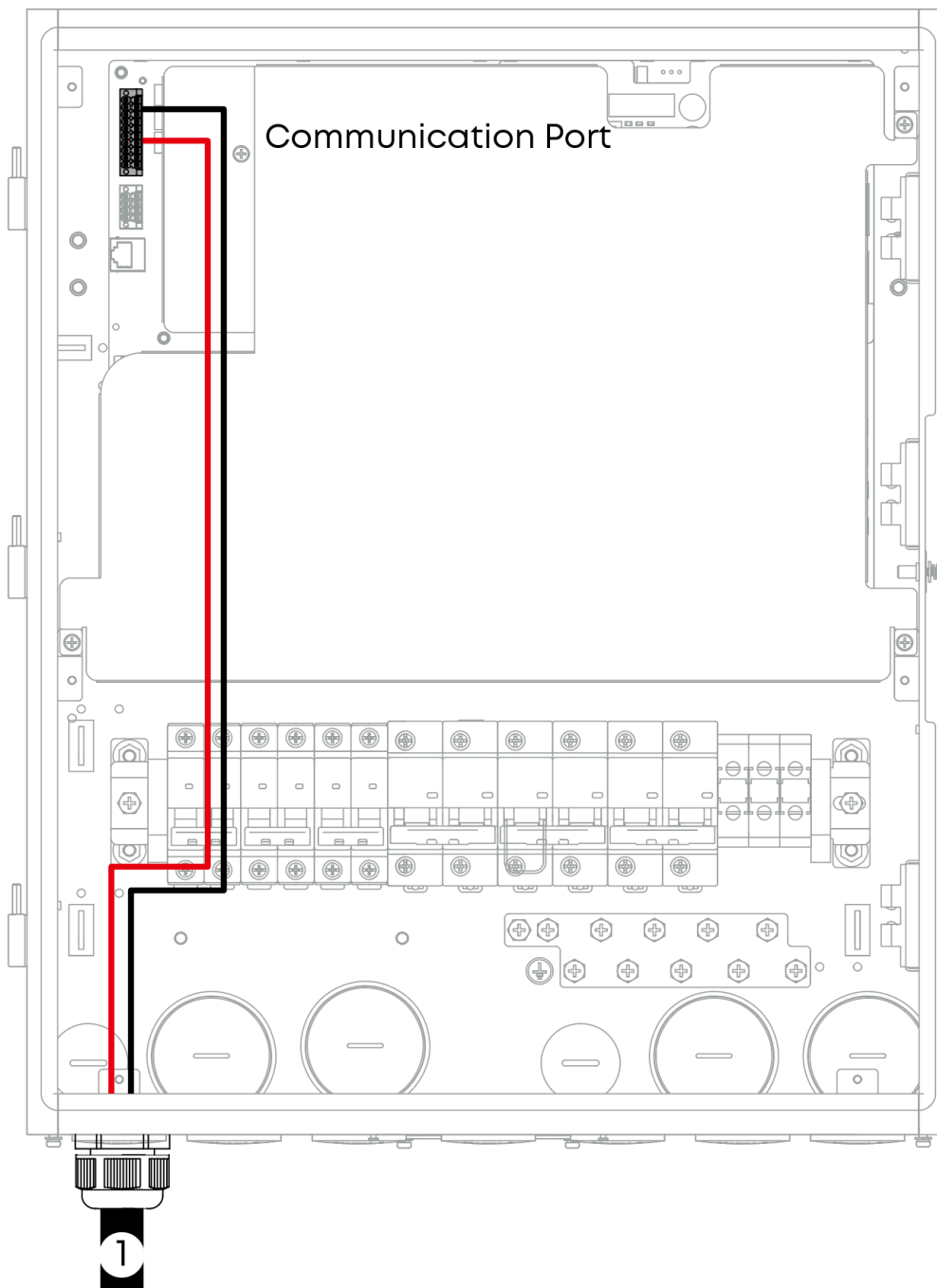

1

With one dual-channel external meter

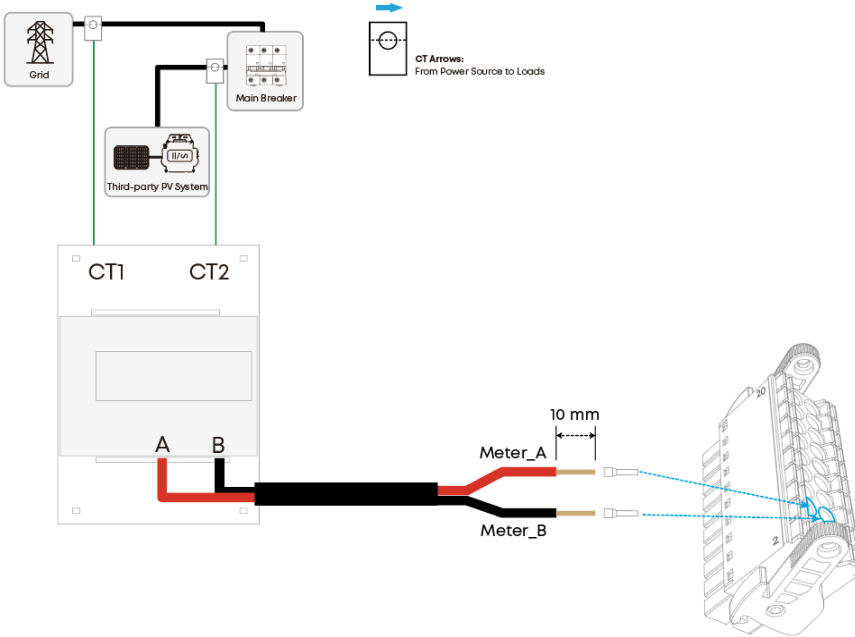

With two single-channel external meters

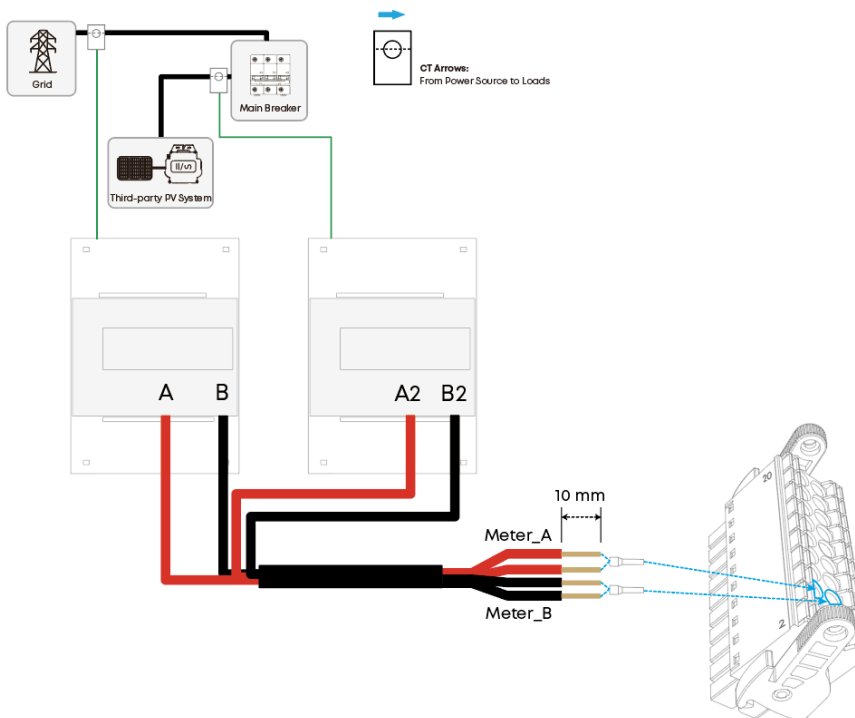

2

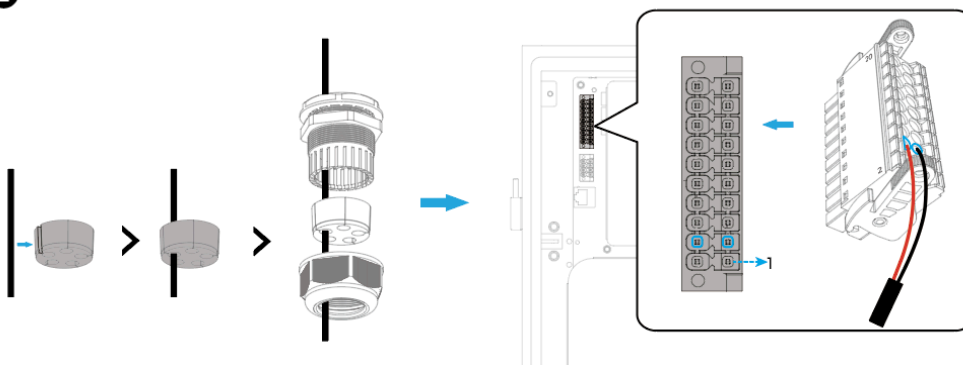

Option 2: Back Cable Entry

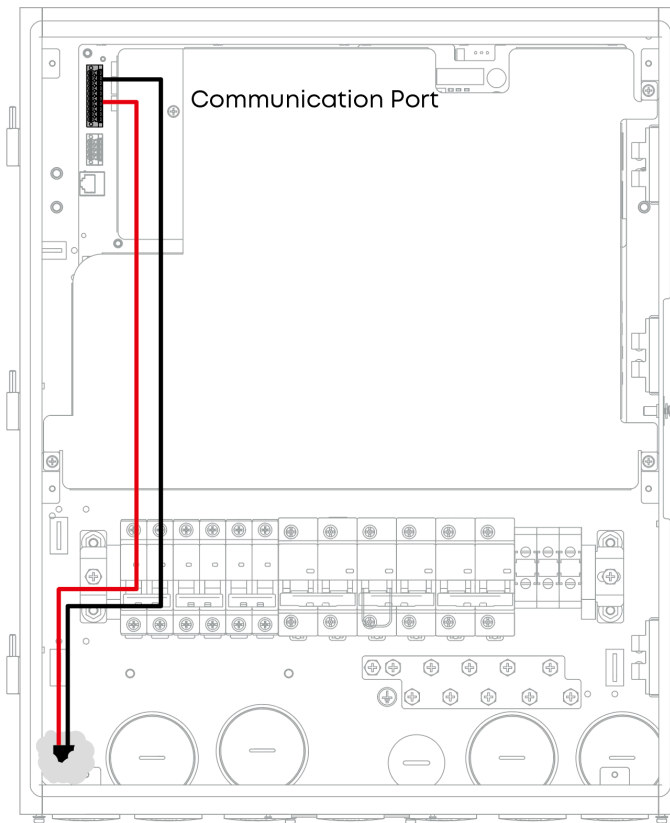

1

With one dual-channel external meter

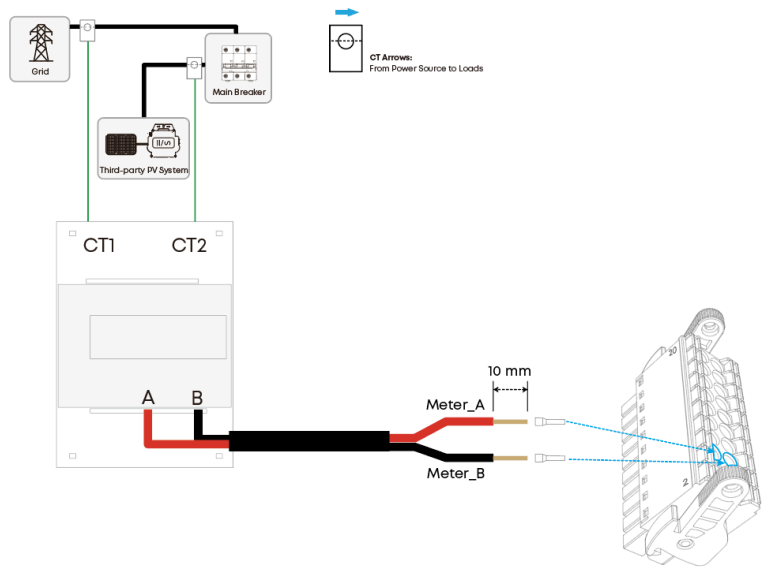

With two single-channel external meters

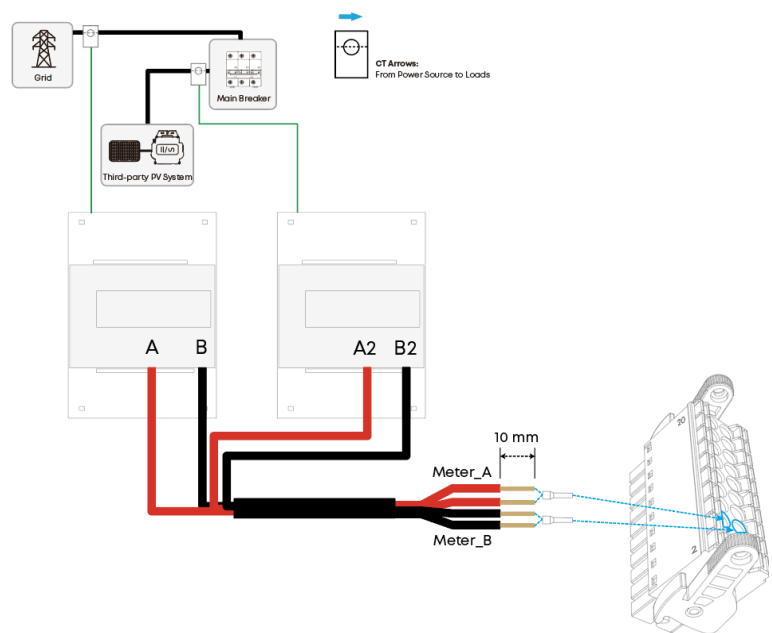

2

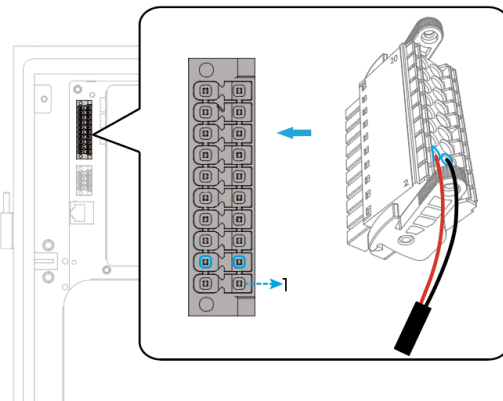

7. Complete Connections

7.1 Tighten / Seal Routing Hole

Bottom Cable Entry

① Tighten the routing holes to complete electrical connections.

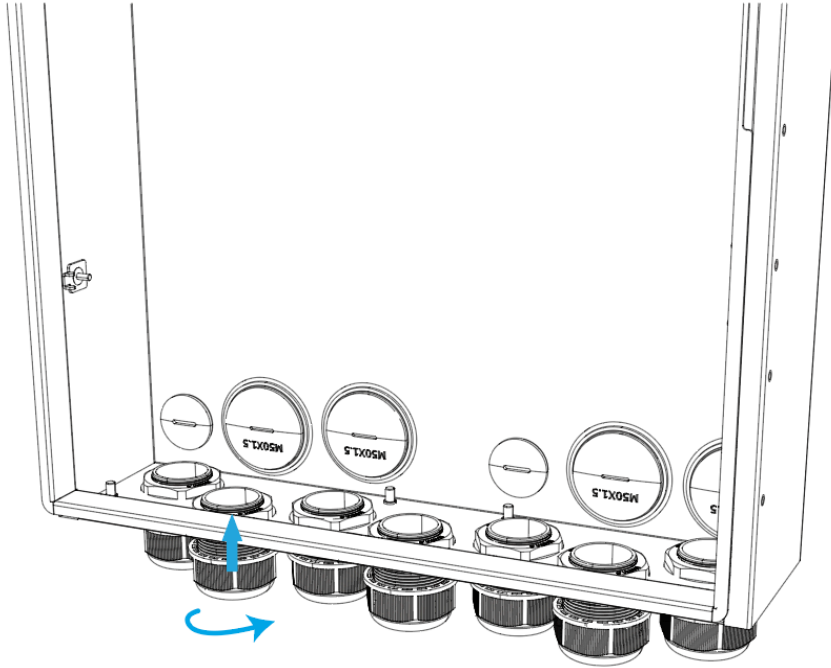

② Fill the gap with sealant.

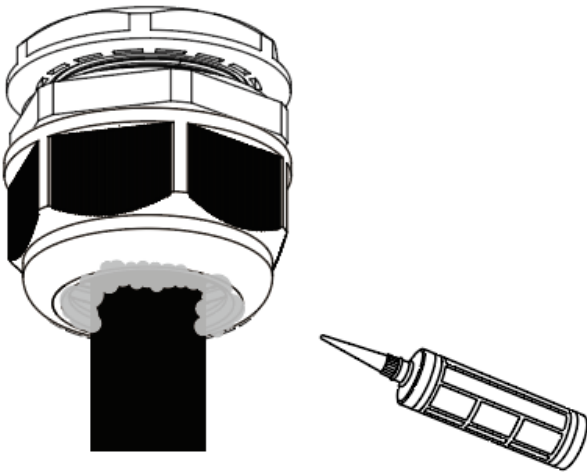

Back Cable Entry

Seal the cable outlets after wiring.

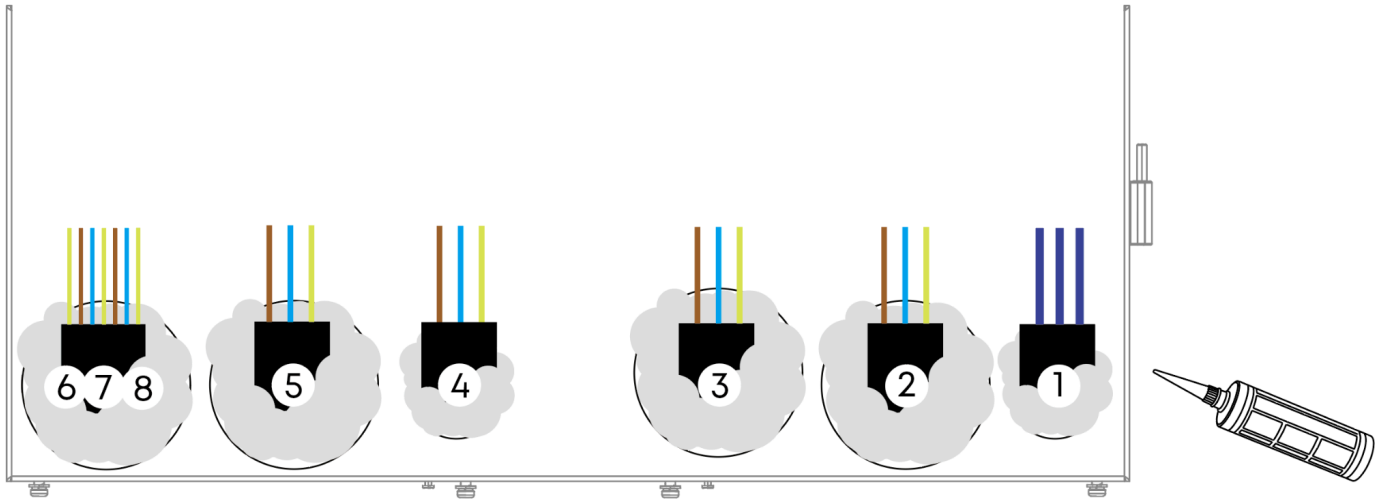

7.2 Install Inner Panel and the Cover

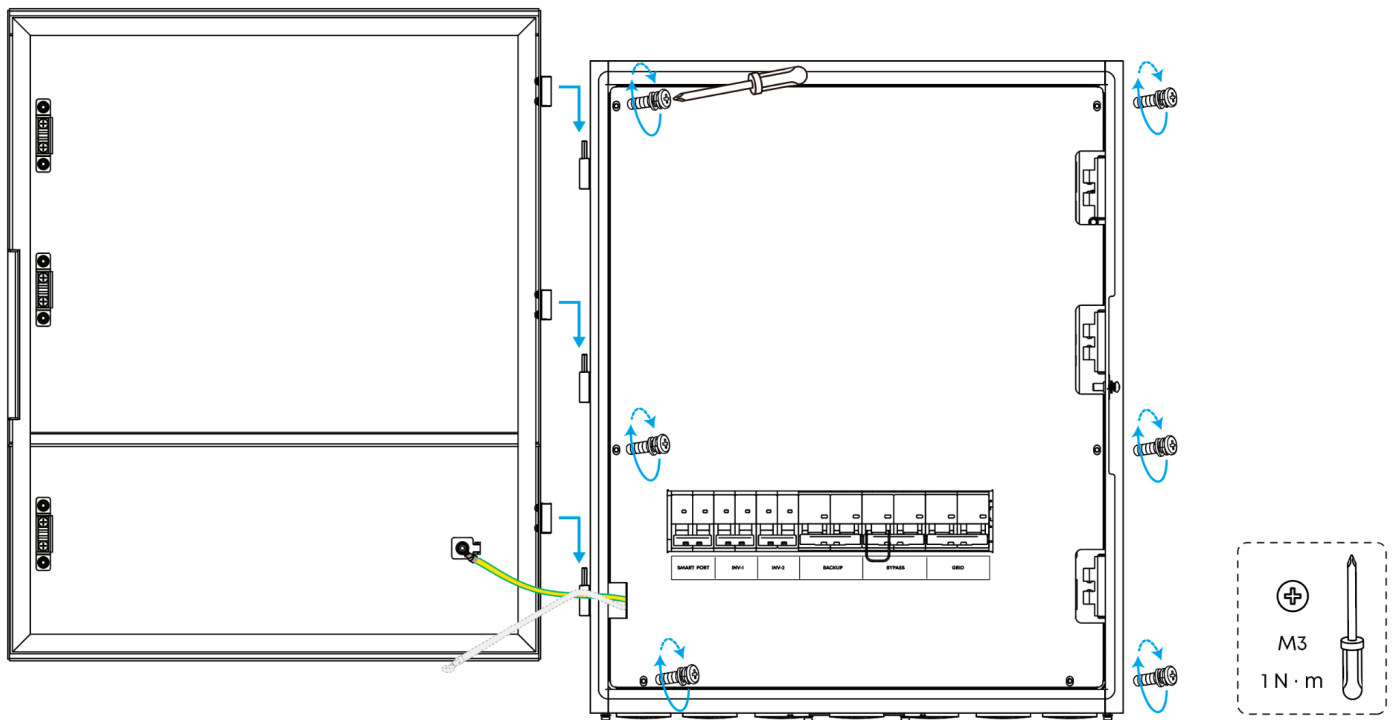

7.3 Install Decorative Cover

1

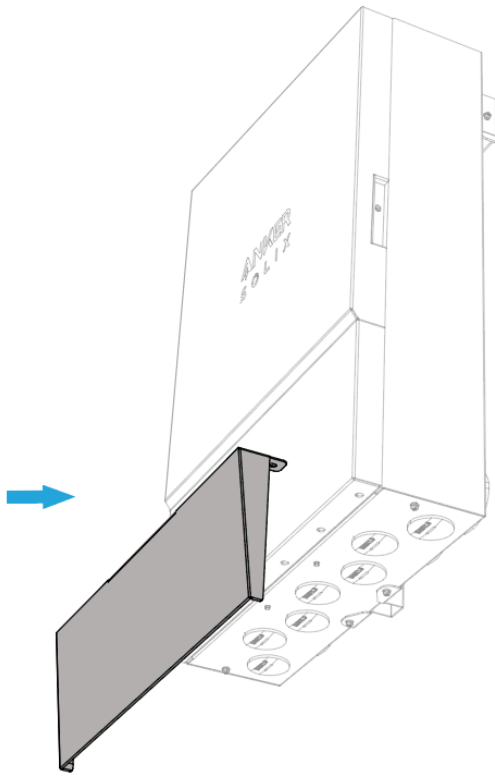

2

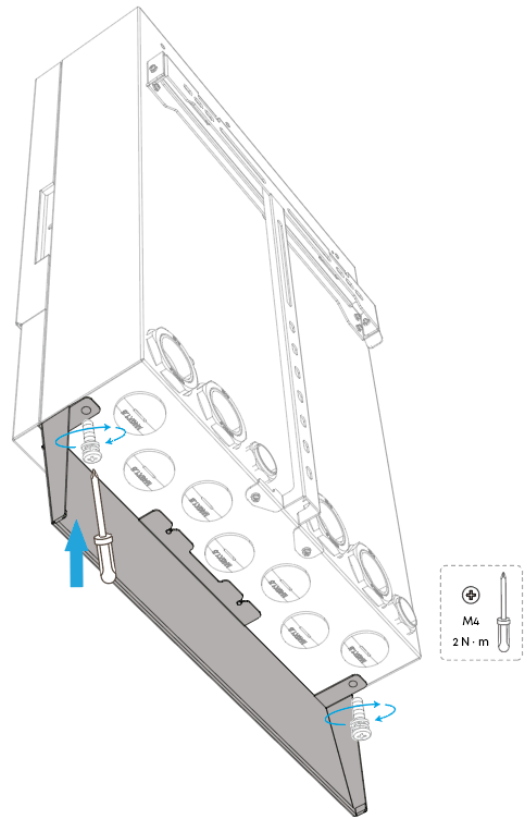

8. Power On



- Black start of the inverter is not recommended when grid power is available.
- If black start must be performed with grid power present, wait at least 1 minute after the inverter completes black start before closing the circuit breaker between the Power Dock Pro and the inverter.

1. Switch on the circuit breakers in the following order: QF5 → QF2 / QF3 → QF1 → QF4.



Keep the Bypass Switch OFF under normal operation.

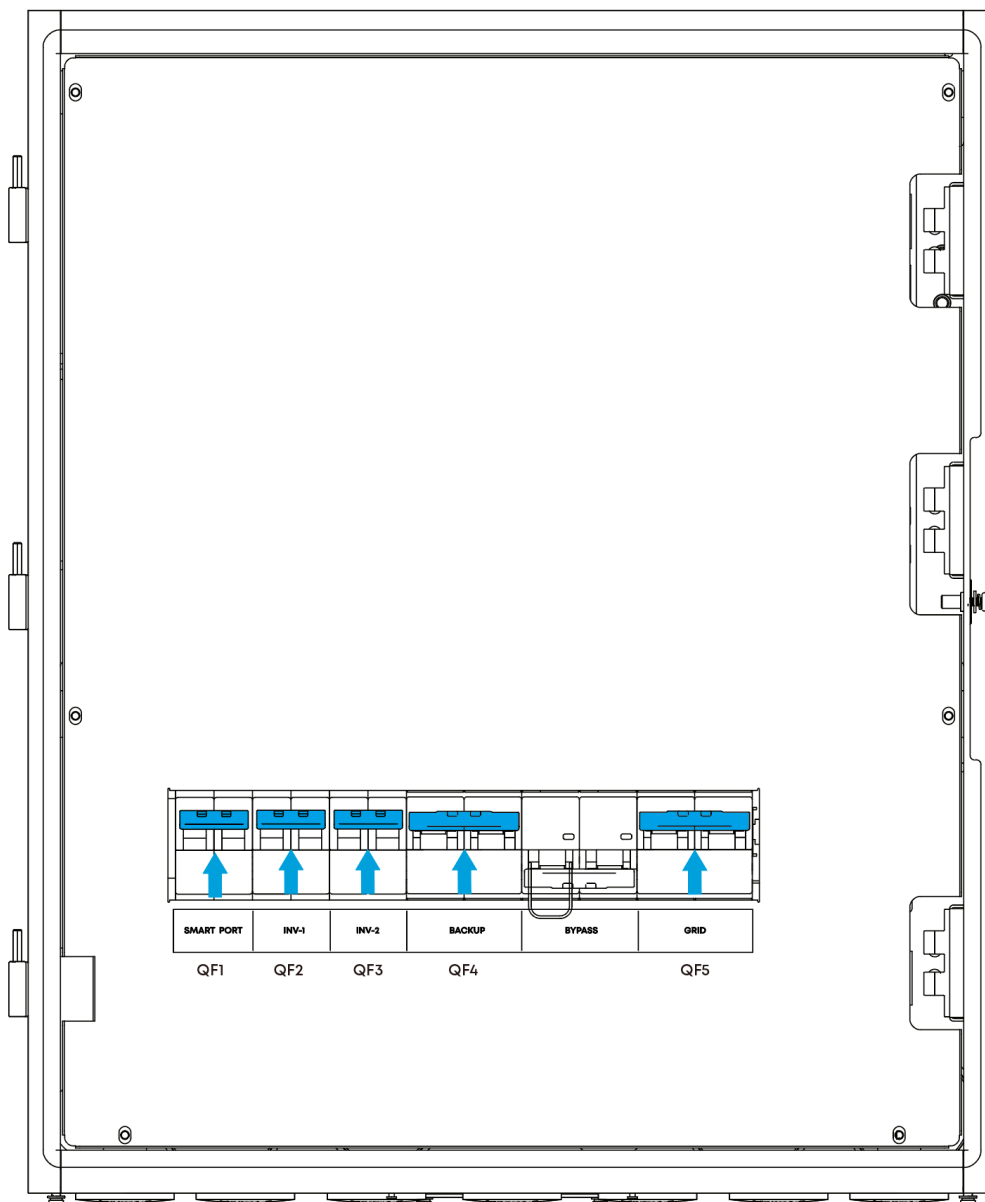

(Optional) Turn on the Bypass Switch



- Turn the Bypass Switch ON only if the Power Dock Pro malfunctions to maintain power supply.
- Before turning the Bypass Switch ON, shut down the inverter and switch off the inverter circuit breakers. For detailed procedures, consult qualified technical support personnel.

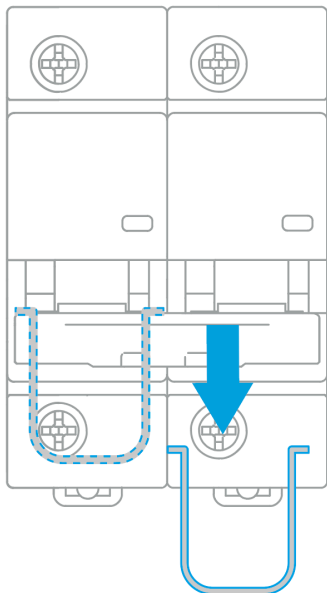

2. Close and lock the equipment door.

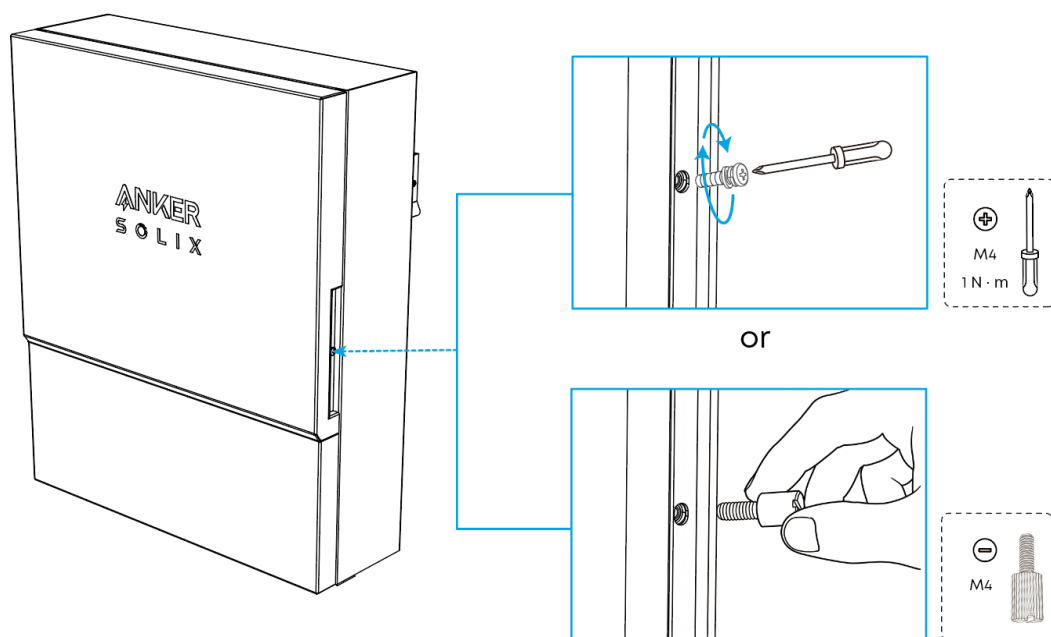

9. Use the Anker SOLIX Professional App



The UI images shown are for illustration only and may not match the actual display, which can vary depending on the software version

9.1 Download and Install the App

1. Download the Anker SOLIX Professional app from the App Store (iOS devices) or Google Play (Android devices), or by scanning the QR code.



2. Log into the app using the installer's account. Please check your email to get the account name and initial password. If you do not have an account, follow the in-app instructions to sign up.

9.2 Build System



If adding a Power Dock Pro to an existing system, start from [Storage Settings > Add Devices](#).

Step 1: Collect Owner Details

- ① On the Home screen, tap [Create System](#) or the plus icon on the top right.
- ② Go to [System Build](#).
- ③ Input the system and owner information.

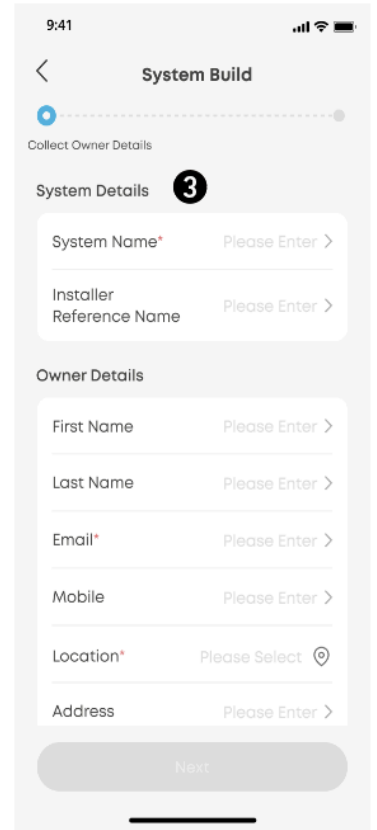
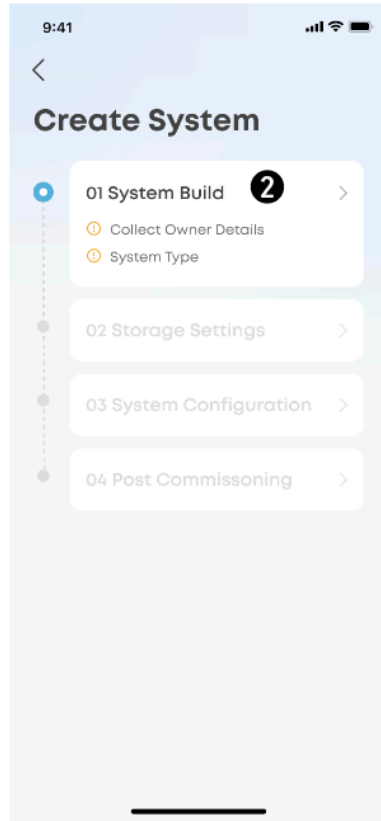
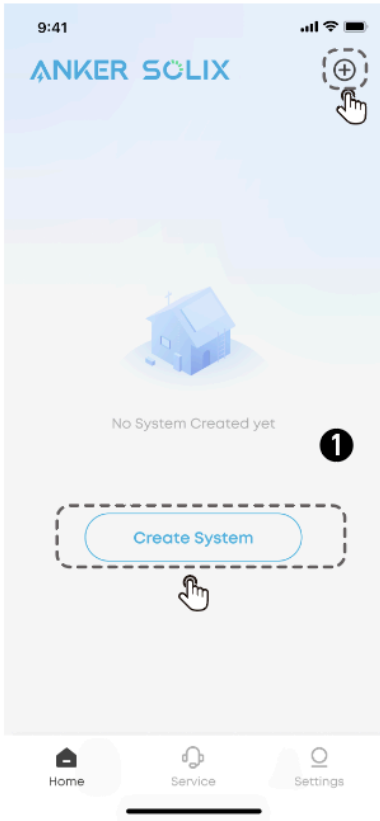

Step 2: Select System Type

Select a system type based on the installation of the energy storage system.

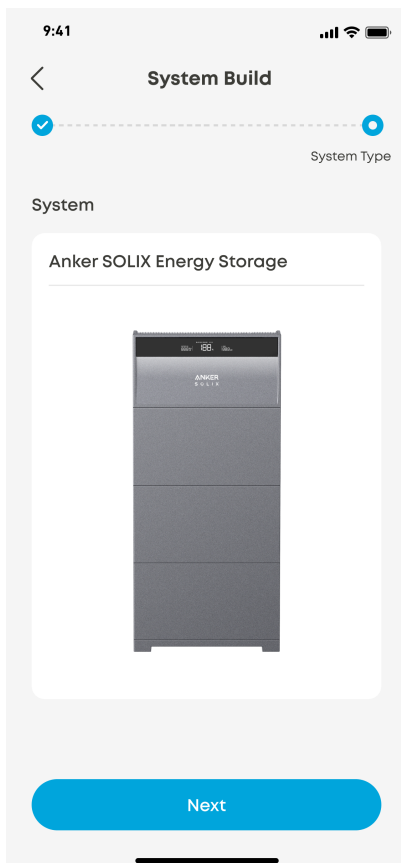

9.3 Storage Settings

Step 1: Connect Device

Connect the power module to the Anker SOLIX Professional app via Bluetooth.

- ① Go to **Storage Settings**.
- ② Select the power module from the Bluetooth device list or scan the barcode on the power module's label.
- ③ Enter the password located below the barcode.

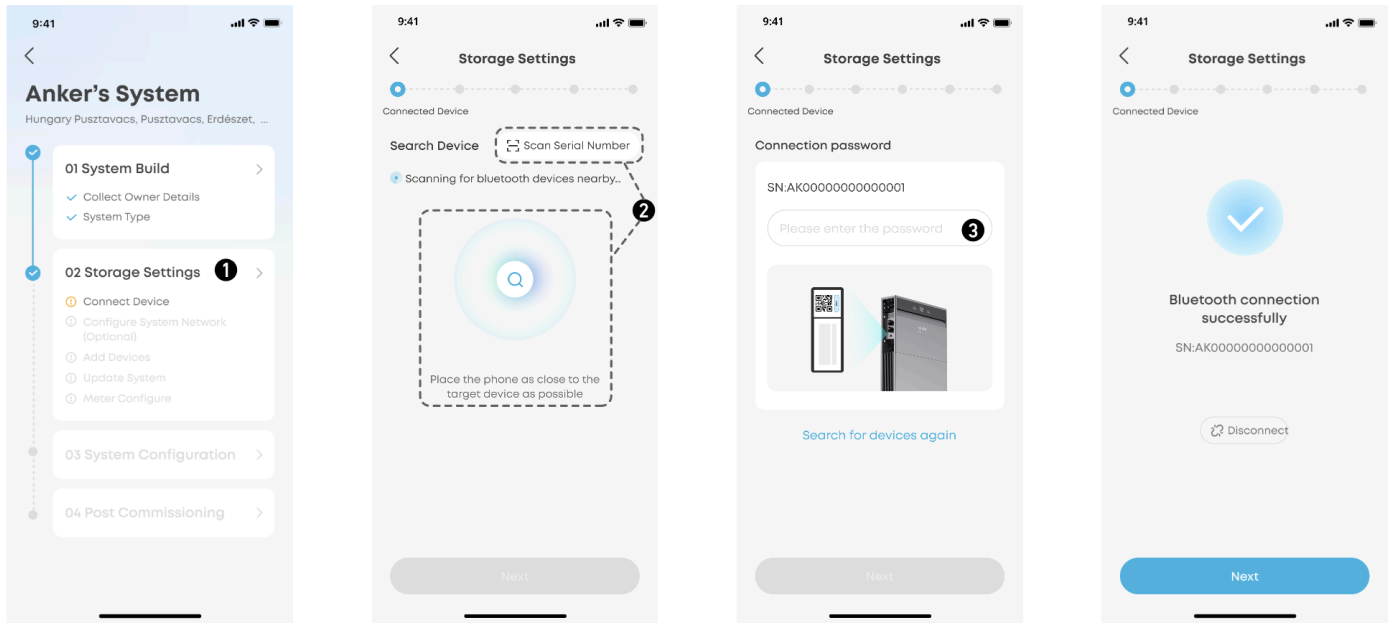

Step 2: Configure System Network (Optional)

Configure the Internet connection using Wi-Fi, Ethernet, or 4G.

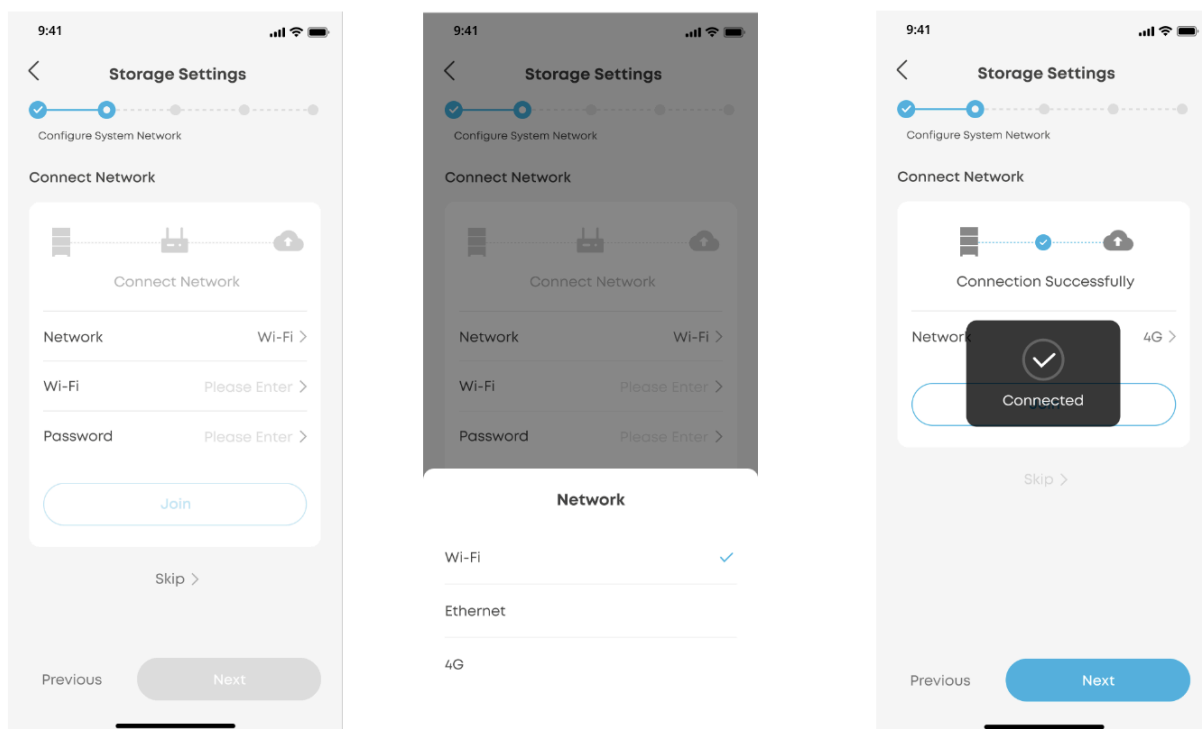

Step 3: Add Devices

① Manually input the numbers of the power modules, battery modules and Power Dock Pro.

*A maximum of one Power Dock Pro can be added per system. Enter 0 if none is installed.

② Tap **Refresh**.

③ Select **Next** to move on when you see the message "The device is added successfully."

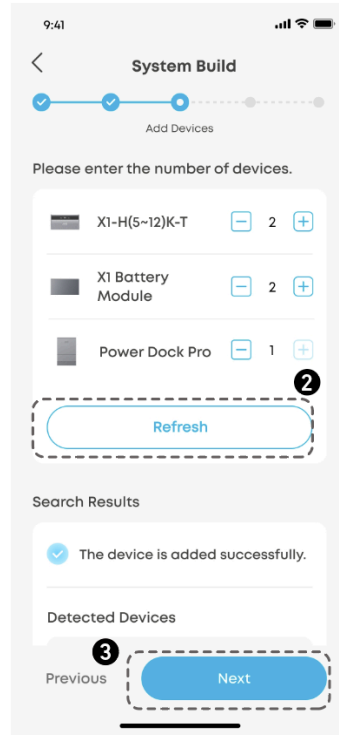
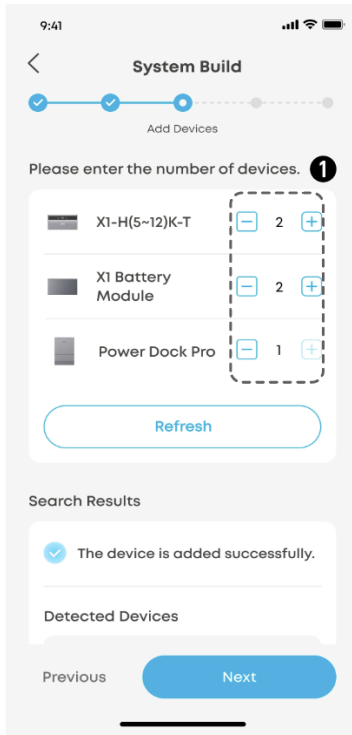

Step 4: Update System

Update the firmware to the latest version.

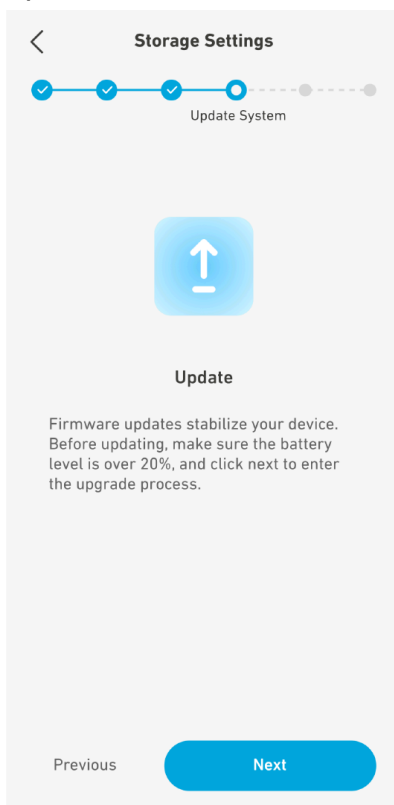

Step 5: Meter Configure

① Configure the meter settings based on your installation scenario:

Scenario 1: No External Meter Required (Toggle OFF)

The built-in CT in the Power Dock Pro can collect data from both Grid Port and Smart Port. No external meter is needed.

Scenario 2: External Meter Required (Toggle ON)

An external meter is required if:

- Power Dock Pro is connected after the main panel (partial home backup)
- Third-party solar system is not connected to the Power Dock Pro Smart Load port

② If an external meter is required, verify the meter wiring against the diagram shown in the app.

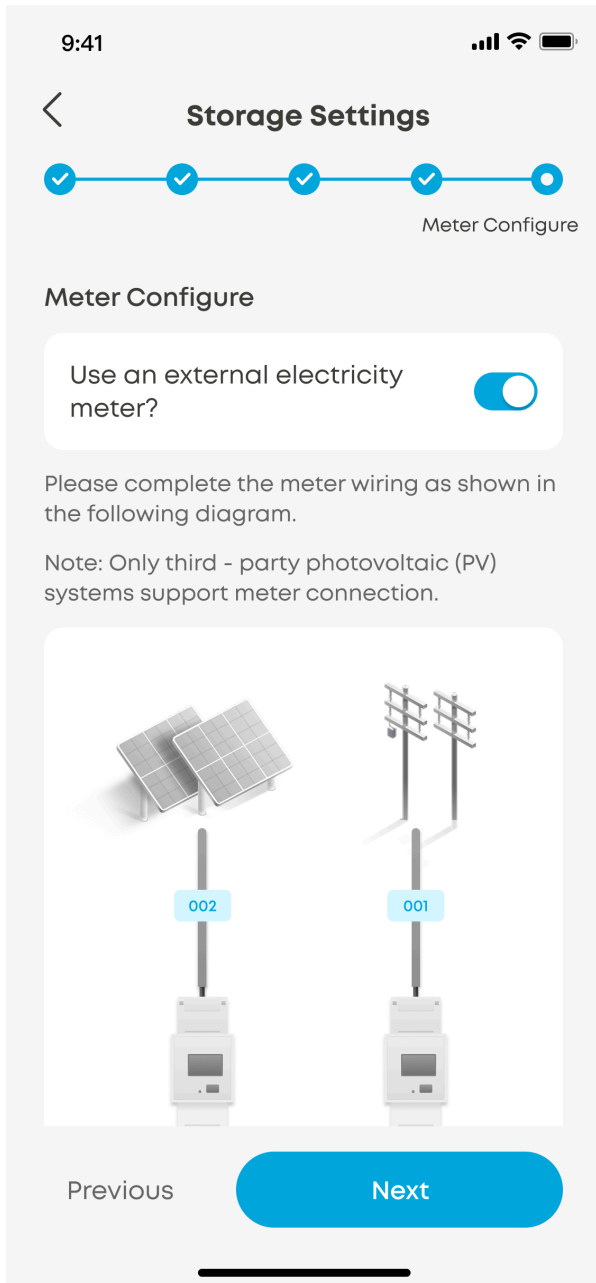

9.4 System Configuration

Step 1: Advanced Configuration

① Select the device connected to the smart port of Power Dock Pro.

Scenario 1: If no device is connected to the smart port, select **Not in Use**, then complete third-party photovoltaic settings.

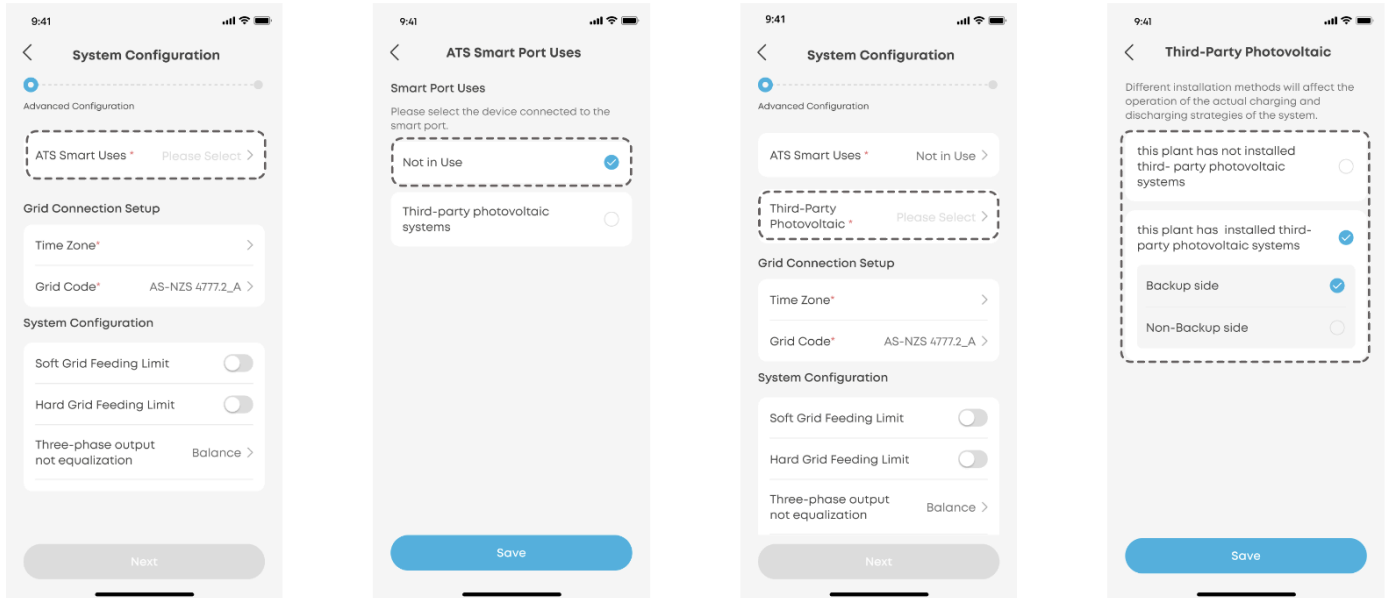

Scenario 2: If a third-party PV system is connected to the smart port, select **Third-party photovoltaic systems**.

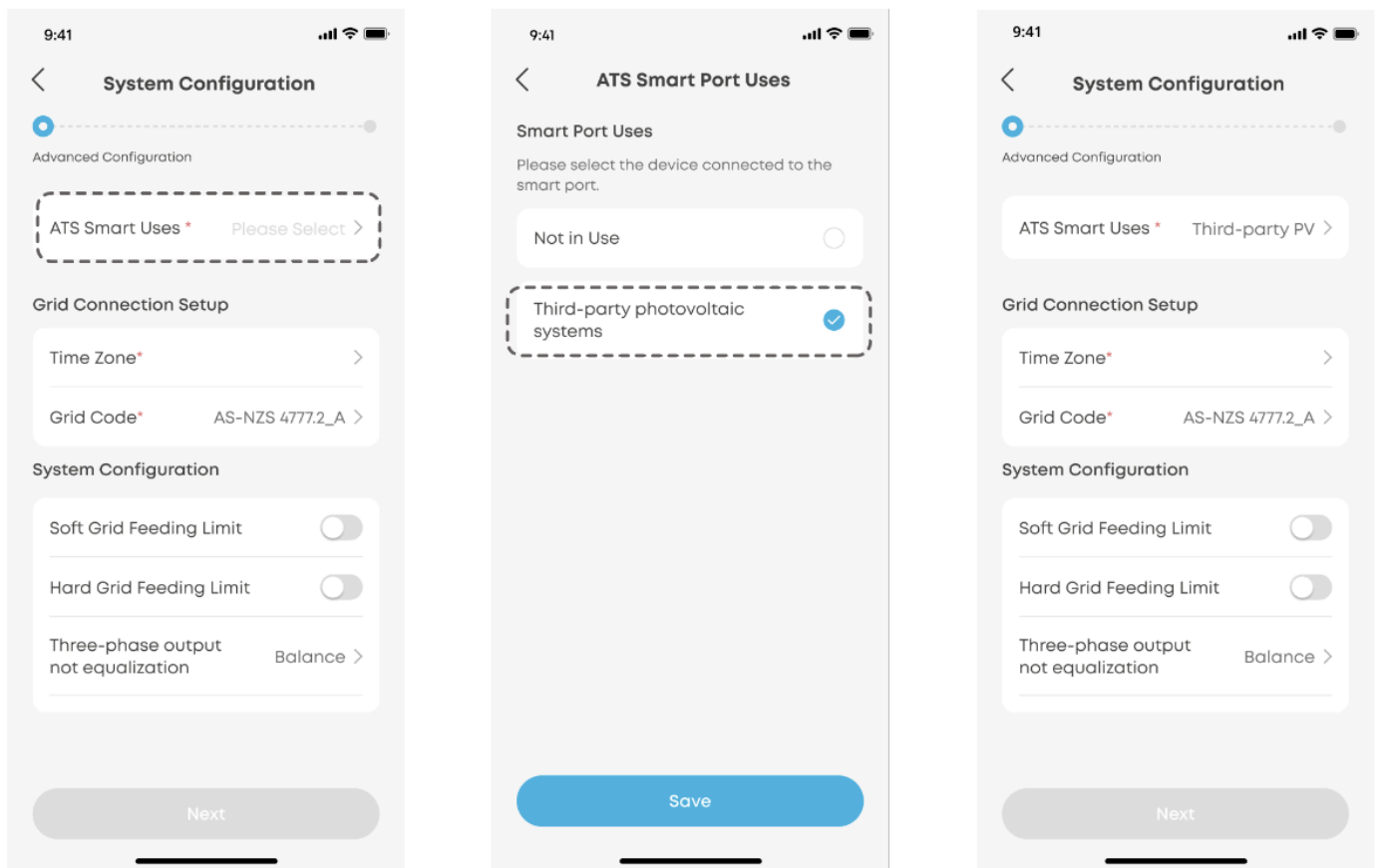

② Complete other system settings.

Step 2: Perform System Test

Tap **Start** to perform the system test.

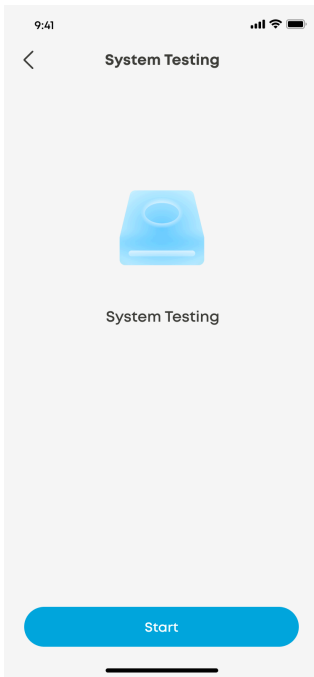

9.5 Post Commissioning

Step 1: Delivery

① Select **Post Commissioning**.

② Enter the owner's e-mail and the verification code. Or you can select **Custody** if the owner's email is unavailable.

Note: If you are an electrician without registered companies, you should enter an installer organization code for selecting Custody.

③ Tap **Next** to proceed.

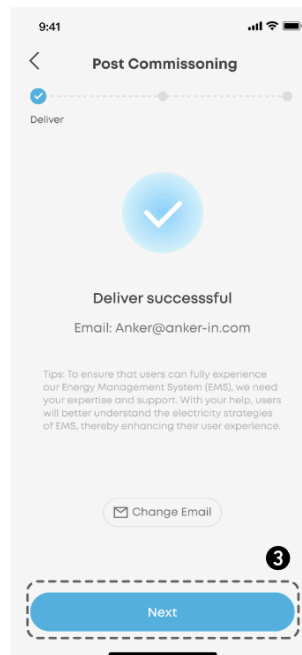
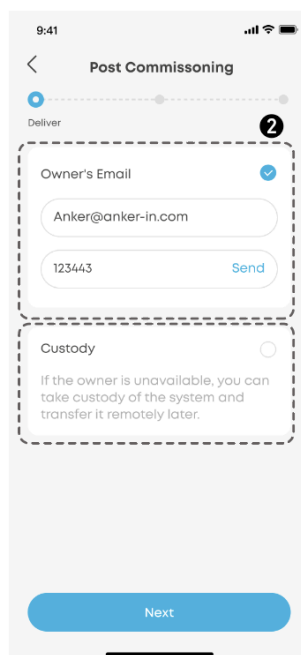
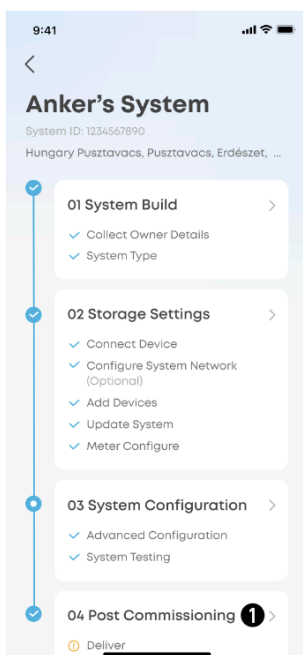

Step 2: Energy Management

① Choose one work mode from the following.

Self-Consumption: Maximize the use of solar power and reduce grid power consumption.

*Note: This mode requires a PV system.

Time of Use: The battery will charge during low-cost electricity hours and discharge during high-cost electricity hours.

Off-Grid: Power your home with solar energy and the stored battery energy when the grid goes down.

Note: The Anker SOLIX X1's off-grid mode is incompatible with the Sunlight Backup mode of the Enphase microinverter. It is necessary to disable the Sunlight Backup mode of the Enphase microinverter before using the Anker SOLIX X1's off-grid mode.

② Set backup reserve by adjusting the slider.

To allow more capacity for the Self-Consumption mode or Time of Use mode, set a lower reserve percentage.

To reserve more energy for outages or if they are frequent in the user's area, set a higher reserve percentage.

③ Select advanced options.

Grid Charging: Turn on to charge battery modules from the grid. Turn off to charge battery modules only from solar power.

Peak Shaving: Set the peak power to prevent tripping or an increase in grid charges (in some areas).

Rapid Battery Charging: Charge the battery modules at full speed using both grid and solar power.

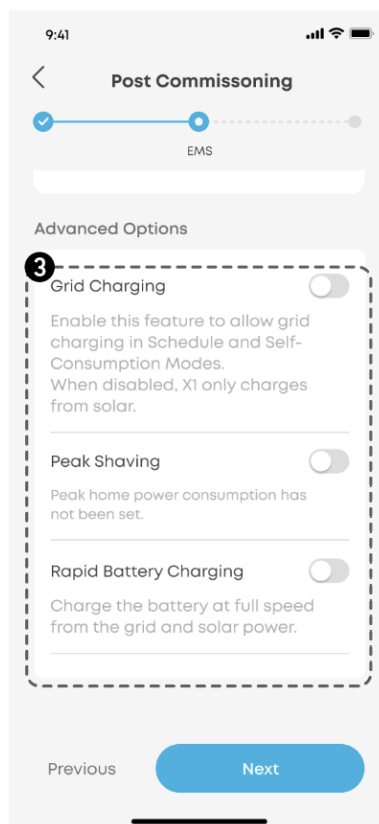
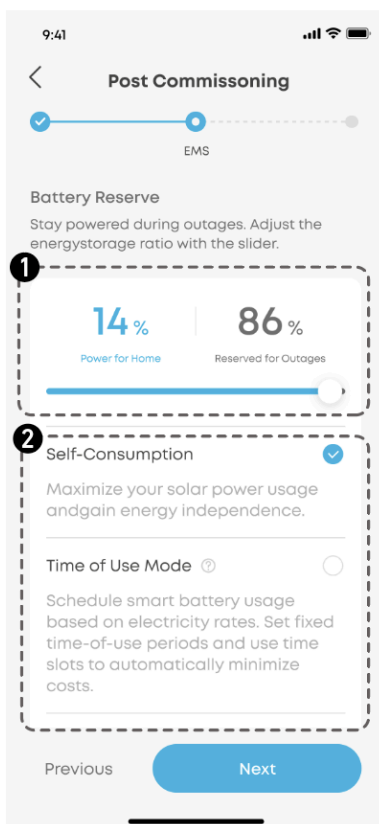

Step 3: Configure External Device (Heat Pump)

① If necessary, add the heat pump to the system and enable the heat pump function.

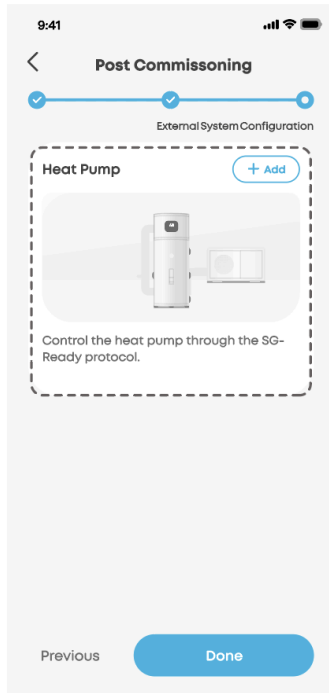

② Select a control mode from the options below.

Auto Mode: The heat pump starts up when the solar power supplied to the grid exceeds the rated power of the heat pump.

Active Rate Power: Enter the rated power of the heat pump.

Active Time: Set the minimum ON duration of the heat pump to avoid rapid ON/OFF cycles.

Starting Protection Delay: Set the minimum OFF duration of the heat pump to avoid rapid ON/OFF cycles.

Schedule Mode: The heat pump operates according to a predefined schedule. You can customize up to four time periods for weekdays and weekends respectively.

Manual Mode: Enable this mode to manually turn the heat pump on or off.

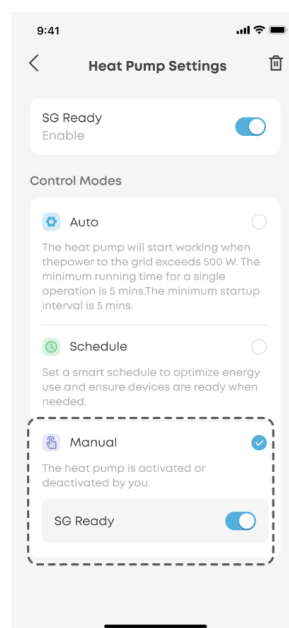
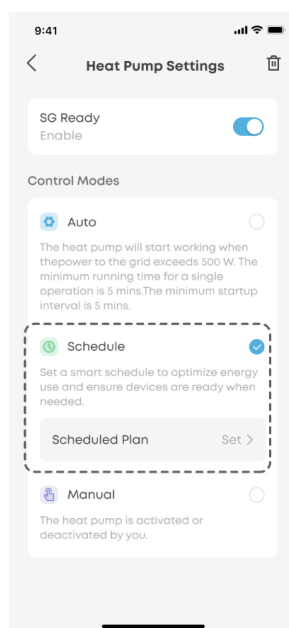
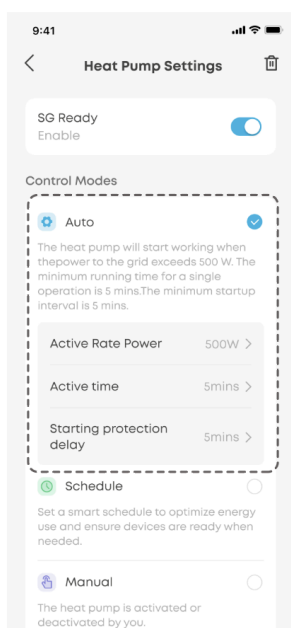

Notice

1. The generator must provide a TN system with a neutral-to-earth (N-PE) connection.
2. Before turning the Bypass Switch ON, switch off the inverter and Smart Port (generator input) circuit breakers to avoid safety hazards.
3. Generator and third-party PV system cannot be used simultaneously.
4. The third-party PV inverter shall comply with the International standard IEC 62109-1:2010 & IEC 62109-2:2011. The third-party PV inverter shall only connect to one of the Smart terminal, Backup terminal or Non-Backup terminal at the same time, which shall be a PV grid-interactive inverter, with no connection with other source or load.

Appendix 1: Specifications

Model Name	Power Dock Pro 63-S-EU
Grid Connection	
Grid Connection Type	Single-Phase
Nominal AC Voltage	220V / 230V / 240V
Nominal AC Input / Output Current	63A
Nominal AC Input / Output Power	13.86kW
Nominal AC Frequency	50 Hz / 60 Hz
Backup Switch Disruption Time ¹	0 ms
AC Output to Backup Port	
Nominal AC Output Voltage	220V / 230V / 240V
Nominal AC Output Current	63A
Nominal AC Output Power	13.86kW
Nominal AC Frequency	50 Hz / 60 Hz
Overvoltage Category	III
Third-Party PV Inverter	Supported
AC Output to Non-Backup Port	
Nominal AC Output Voltage	220V / 230V / 240V
Nominal AC Output Current	63A
Nominal AC Output Power	13.86kW
Nominal AC Frequency	50 Hz / 60 Hz
Inverter Connection (INV1 and INV2)²	
Nominal AC Voltage	220V / 230V / 240V
Nominal AC Input / Output Current	54.6A
Nominal AC Input / Output Power	12kW
Smart Port Connection³	
Nominal AC Voltage	220V / 230V / 240V
Nominal AC Input / Output Current	45.6A
Nominal AC Input / Output Power	10kW
Third-Party PV Inverter	Supported
Generator function	Reserved for future support

General Data	
Dimensions (W × H × D) ⁴	450 × 550 × 155 mm
Weight ⁴	19 kg
Storage Temperature Range	-30°C - +70°C
Operating Temperature Range ⁵	-20°C - +55°C
Relative Humidity Range	0 - 95% RH
Max Operation Altitude ⁶	4,000 m
Cooling Mode	Natural cooling
Ingress Protection Rating	IP55
Noise	25 dB
Communication	CAN, RS485, Dry Contact
Installation Method	Wall-Mounted
Cable Entry	Bottom / Rear
Note :	
<p>1. Refers to load-side disruption time. To enable this functionality, Anker SOLIX Power Dock Pro must be used in conjunction with Anker SOLIX X1 Power Module and Anker SOLIX X1 Battery Module. Test Condition: During a grid outage, the rated power of Anker SOLIX X1 Power Module must exceed the total power of the backup loads.</p>	
2. Combined Input Power Limit (INV1 + INV2): 12 kW (single-phase) / 36 kW (three-phase);	
3. Combined Input Power Limit (Smart Port + INV1 + INV2): 13.86 kW (single-phase) / 41.58 kW (three-phase);	
4. Decorative cover not included.	
<p>5. -20°C to +45°C: no derating; +45°C to +55°C: No automatic derating. Derating should be determined based on local climate and temperature conditions. Grid / Backup / Non-Backup: current derated to 54.6 A; INV1 / INV2: current derated to 45 A (single-phase) / 38 A (three-phase); Smart Port: current derated to 38 A; Combined Input Power Limit (Smart Port + INV1 + INV2): 12 kW (single-phase) / 36 kW (three-phase);</p>	
6. Maximum PV Input Voltage: 875VDC @ 4,000 m; 980VDC @ 3,000 m; 1,000VDC @ 2,000 m.	

Appendix 2: Compatible Devices

Compatible Meters

Product Name	Product Number	Model Name	Meter Type
Power Sensor	DTSU666	A5420G22	No CT
		A5430G21 (100A) A5430G23 (250A)	3 CTs; Single-Channel
		A5430G23	6 CTs; Dual-Channel
		A5420G24	2 CTs; Dual-Channel

Compatible Inverters

Product Name	Product Number	Model Name
Anker SOLIX X1 Power Module	A5102	X1-H3.68K-S X1-H4.6K-S X1-H5K-S X1-H6K-S X1-H5K-S BE